

***XPress***

*Price list – 1st March 2011*

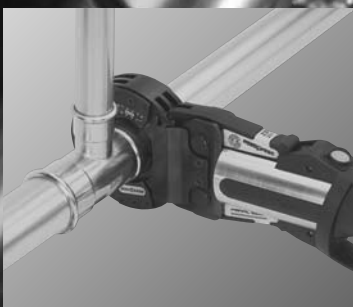

## The Press-fit Jointing System

<i>XPress Specials Range</i>	3
<i>XPress Copper Fittings</i>	3-6
<i>Stainless Steel 316 System Tube</i>	7
<i>XPress Stainless Fittings</i>	7-8
<i>Carbon Steel System Tube</i>	8
<i>XPress Carbon Fittings</i>	8-10
<i>XPress Copper Gas Fittings</i>	11-12
<i>XPress Stainless Gas Fittings</i>	13
<i>XPress Solar Fittings</i>	14-15
<i>Accessories</i>	16
<i>Tools and Jaws</i>	17

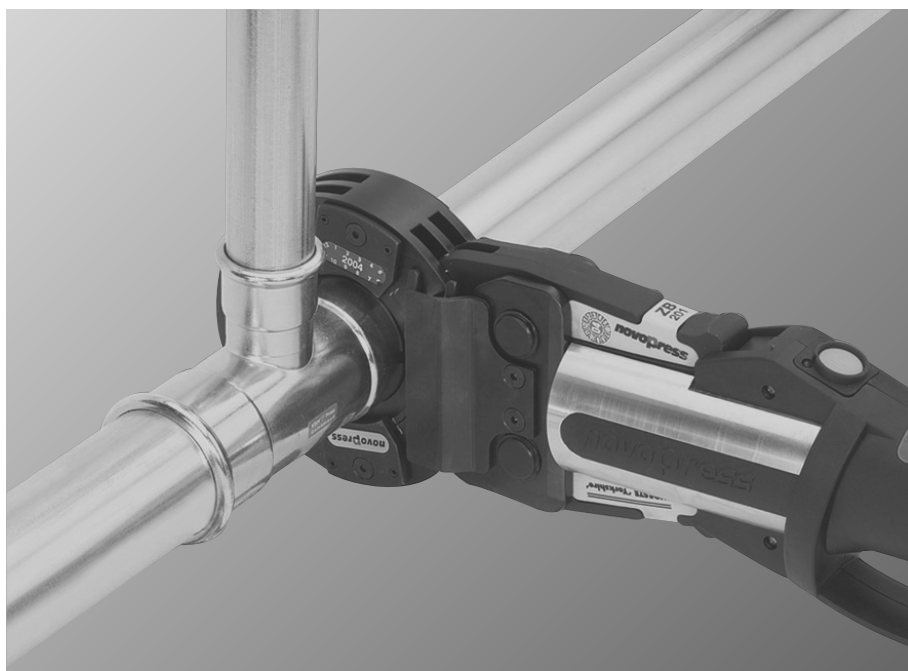

### XPress Specials Range

**SP1/7270**  
**Straight Coupling**  
Press-fit x press-fit

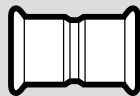

SIZE	BOX QTY	CODE	£ EACH
15mm	10	38010	1.85
22mm	10	38020	2.89

**SP3/6243G**  
**Straight Male Connector**  
Press-fit x BSP taper male thread

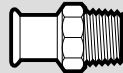

SIZE	BOX QTY	CODE	£ EACH
15mm x 1/2"	10	38114	6.73

**SP6/7243**  
**Reducer**  
Larger end male for insertion into fitting x press-fit



SIZE	BOX QTY	CODE	£ EACH
22 x 15mm	10	38200	2.14

**SP12/7002A**  
**Elbow**  
Press-fit x press-fit



SIZE	BOX QTY	CODE	£ EACH
15mm	10	38280	1.99
22mm	10	38290	3.37
28mm	5	38300	7.23

**SP12S/7001A**  
**Street Elbow**  
Press-fit x male end  
For insertion into fitting



SIZE	BOX QTY	CODE	£ EACH
15mm	10	38318	2.02
22mm	10	38320	3.49

**SP24/7130**  
**Equal Tee**  
Press-fit on all ends

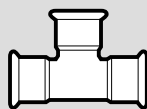

SIZE	BOX QTY	CODE	£ EACH
15mm	10	38450	3.20
22mm	10	38460	5.80

**SP25/7130**  
**Tee, reduced branch**  
Press-fit on all ends

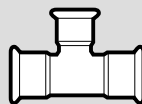

SIZE	BOX QTY	CODE	£ EACH
22 x 22 x 15mm	10	38490	4.72

### XPress Copper Fittings

**S1/7270**  
**Straight Coupling**  
Press-fit x press-fit

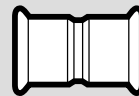

SIZE	BOX QTY	CODE	£ EACH
12mm	10	38009	2.15
15mm	10	38010	1.85
18mm	10	38011	2.29
22mm	10	38020	2.89
28mm	5	38030	6.09
35mm	5	38032	7.67
42mm	1	38034	13.79
54mm	1	38035	17.59
67mm	1	38036	42.48
76mm	1	38037	54.99
108mm	1	38038	95.69

**Chrome plated – S1CP / 7270**

SIZE	BOX QTY	CODE	£ EACH
12mm	10	38610	3.76
15mm	10	38611	3.29
22mm	10	38612	5.16

**S1R/7240**  
**Reduced Coupling**  
Press-fit x press-fit

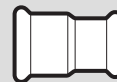

SIZE	BOX QTY	CODE	£ EACH
15 x 12mm	10	38063	7.32
22 x 15mm	10	38064	8.28
28 x 15mm	10	38065	15.23
28 x 22mm	10	38066	19.15
35 x 28mm	5	38067	26.81
42 x 35mm	1	38068	48.25
54 x 42mm	1	38069	61.57

**Chrome plated – S1RCP / 7240S**

SIZE	BOX QTY	CODE	£ EACH
15 x 12mm	10	38616	12.82
22 x 15mm	10	38617	14.49

**S1FMF/7510**  
**Composite Flange**  
Female copper press-fit socket with powder coated steel outer flange to BS 4504 type 133, PN 16 rated



SIZE	BOX QTY	CODE	£ EACH
67mm DN65 (2 1/2") (4 holes)	1	38364	126.94
76mm DN80 (3") (8 holes)	1	38365	150.40
108mm DN100 (4") (8 holes)	1	38367	177.49

**S1FMM/7520**  
**Composite Flange**  
Press-fit x male end for insertion into fitting. Male copper spigot connector for insertion into press-fit socket with powder coated steel outer flange to BS 4504 type 133, PN 16 rated



SIZE	BOX QTY	CODE	£ EACH
67mm DN65 (2 1/2") (4 holes)	1	38359	115.10
76mm DN80 (3") (8 holes)	1	38360	134.69
108mm DN100 (4") (8 holes)	1	38362	159.36

**S1 Slip/7270S**  
**Straight Coupling Slip Pattern**  
Press-fit x press-fit



SIZE	BOX QTY	CODE	£ EACH
15mm	5	38044	3.90
18mm	5	38054	4.96
22mm	5	38045	6.09
28mm	5	38046	9.04
35mm	5	38047	11.52
42mm	1	38048	16.56
54mm	1	38049	21.09
67mm	1	38040	61.59
76mm	1	38041	78.49
108mm	1	38043	124.18

**Chrome plated – S1 Slip CP / 7270S**

SIZE	BOX QTY	CODE	£ EACH
15mm	10	38614	6.83

**S2/6270G**  
**Straight Female Connector**  
Press-fit x BSP parallel female thread



SIZE	BOX QTY	CODE	£ EACH
12mm x 3/8"	5	38082	6.80
12mm x 1/2"	5	38081	6.67
15mm x 3/8"	5	38083	6.93
15mm x 1/2"	10	38090	7.84
15mm x 3/4"	5	38091	8.23
18mm x 1/2"	5	38084	9.06
18mm x 3/4"	5	38085	10.96
22mm x 1/2"	5	38086	9.82
22mm x 3/4"	5	38092	10.34
22mm x 1"	5	38087	11.37
28mm x 3/4"	5	38088	19.14
28mm x 1"	5	38093	13.95
28mm x 1 1/4"	5	38103	20.08
35mm x 3/4"	5	38080	27.25
35mm x 1"	5	38089	27.25
35mm x 1 1/4"	5	38094	27.25
42mm x 1 1/4"	1	38101	36.15
42mm x 1 1/2"	1	38095	38.92
54mm x 2"	1	38096	66.74

**Chrome plated – S2CP / 6270G**

SIZE	BOX QTY	CODE	£ EACH
12mm x 3/8"	5	38619	11.90
12mm x 1/2"	5	38620	11.67
15mm x 3/8"	10	38621	12.13
15mm x 1/2"	10	38622	13.72

**XPress Copper Fittings (contd)**

**S3/6243G**  
**Straight Male Connector**  
Press-fit x BSP taper male thread

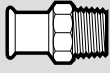

SIZE	BOX QTY	CODE	£ EACH
12mm x 3/8"	5	38105	7.74
12mm x 1/2"	5	38106	7.83
15mm x 3/8"	5	38107	8.02
15mm x 1/2"	10	38114	6.73
15mm x 3/4"	5	38115	8.02
18mm x 1/2"	5	38108	10.37
18mm x 3/4"	5	38109	12.60
22mm x 1/2"	5	38110	11.28
22mm x 3/4"	10	38116	10.16
22mm x 1"	5	38117	11.09
28mm x 3/4"	5	38111	16.20
28mm x 1"	5	38118	13.60
28mm x 1 1/4"	5	38127	17.76
35mm x 1"	5	38112	24.60
35mm x 1 1/4"	5	38119	24.60
42mm x 1 1/4"	1	38113	34.86
42mm x 1 1/2"	1	38120	32.97
54mm x 2"	1	38121	63.63
67mm x 2 1/2"	1	38122	122.21
76mm x 2 1/2"	1	38126	207.62
76mm x 3"	1	38123	211.51
108mm x 4"	1	38124	366.20

**Chrome plated – S3CP / 6243G**

12mm x 3/8"	5	38627	13.55
12mm x 1/2"	5	38628	13.69
15mm x 3/8"	10	38629	14.04
15mm x 1/2"	10	38630	12.00

**S6/7243**  
**Reducer**  
Larger end male for insertion into fitting x press-fit

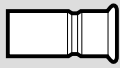

SIZE	BOX QTY	CODE	£ EACH
15 x 12mm	10	38193	2.91
18 x 12mm	10	38196	3.14
18 x 15mm	10	38197	3.14
22 x 15mm	10	38200	2.14
22 x 18mm	10	38201	3.88
28 x 15mm	10	38202	5.79
28 x 18mm	5	38203	5.85
28 x 22mm	10	38204	5.98
35 x 22mm	5	38207	7.19
35 x 28mm	5	38208	7.97
42 x 22mm	1	38210	12.43
42 x 28mm	1	38211	11.84
42 x 35mm	1	38212	11.84
54 x 28mm	1	38215	18.87
54 x 35mm	1	38216	16.04
54 x 42mm	1	38217	16.04
67 x 28mm	1	38218	46.63
67 x 35mm	1	38219	46.63
67 x 42mm	1	38220	46.63
67 x 54mm	1	38221	56.45
76 x 35mm	1	38222	68.17
76 x 42mm	1	38223	68.17
76 x 54mm	1	38224	61.17
76 x 67mm	1	38225	61.17
108 x 42mm	1	38228	99.98
108 x 54mm	1	38229	93.95
108 x 67mm	1	38230	102.48
108 x 76mm	1	38231	102.48

**Chrome plated – S6CP / 7243**

15 x 12mm	10	38636	5.09
18 x 12mm	10	38637	5.50
18 x 15mm	10	38638	5.50
22 x 15mm	10	38639	3.81

**S7/6246G**  
**Female Adaptor**  
Male end for insertion into fitting x BSP parallel female thread



SIZE	BOX QTY	CODE	£ EACH
15mm x 1/2"	10	38160	4.10
18mm x 1/2"	10	38157	4.98
18mm x 3/4"	10	38158	5.18
22mm x 1/2"	10	38159	5.29
22mm x 3/4"	10	38161	5.29
28mm x 3/4"	5	38166	8.32
28mm x 1"	5	38162	7.08
35mm x 1"	5	38167	14.06
35mm x 1 1/4"	1	38163	14.26
42mm x 1 1/2"	1	38164	21.64
54mm x 2"	1	38165	26.78

**S8/6280G**  
**Male Adaptor**  
Male end for insertion into fitting x BSP taper male thread

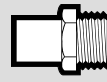

SIZE	BOX QTY	CODE	£ EACH
15mm x 1/2"	5	38170	3.00
18mm x 1/2"	1	38173	3.89
18mm x 3/4"	5	38174	4.05
22mm x 1/2"	5	38175	4.67
22mm x 3/4"	5	38171	4.05
28mm x 1"	5	38172	6.17
35mm x 1 1/4"	1	38176	22.02
42mm x 1 1/2"	1	38177	37.21

**Chrome plated – S8CP / 6280G**

15mm x 1/2"	5	38642	5.25
-------------	---	-------	------

**S11/6330**  
**Union Coupling**  
Press-fit x press-fit

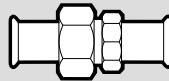

SIZE	BOX QTY	CODE	£ EACH
15mm	5	38180	11.98
18mm	5	38179	16.39
22mm	5	38181	18.27
28mm	5	38182	25.79
35mm	5	38183	53.36
42mm	1	38184	73.01
54mm	1	38185	80.03

**S12/7002A**  
**Elbow**  
Press-fit x press-fit



SIZE	BOX QTY	CODE	£ EACH
12mm	10	38279	2.81
15mm	10	38280	1.99
18mm	10	38282	2.96
22mm	10	38290	3.37
28mm	5	38300	7.23
35mm	5	38302	15.16
42mm	1	38304	28.48
54mm	1	38306	39.52
67mm	1	38307	67.76
76mm	1	38308	108.31
108mm	1	38310	199.31

**Chrome plated – S12CP / 7002A**

12mm	10	38645	4.92
15mm	10	38646	3.55
22mm	10	38647	6.00

**S12S/7001A**  
**Street Elbow**  
Press-fit x male end  
For insertion into fitting

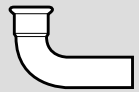

SIZE	BOX QTY	CODE	£ EACH
12mm	10	38317	2.94
15mm	10	38318	2.02
18mm	10	38319	3.12
22mm	10	38320	3.49
28mm	5	38322	8.99
35mm	5	38324	15.66
42mm	1	38325	30.65
54mm	1	38326	41.17
67mm	1	38327	77.92
76mm	1	38328	113.73
108mm	1	38330	199.31

**Chrome plated – S12SCP / 7001A**

12mm	10	38649	5.14
15mm	10	38650	3.60
22mm	10	38651	6.23

**S13/6092G**  
**Male Elbow**  
Press-fit x BSP taper male thread

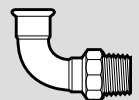

SIZE	BOX QTY	CODE	£ EACH
12mm x 3/8"	5	38371	10.64
12mm x 1/2"	5	38370	10.31
15mm x 3/8"	5	38339	11.72
15mm x 1/2"	10	38333	11.10
18mm x 1/2"	5	38340	15.89
18mm x 3/4"	5	38372	15.89
22mm x 3/4"	5	38334	17.37
28mm x 1"	5	38335	26.62
35mm x 1 1/4"	5	38336	34.60
42mm x 1 1/2"	1	38337	45.13
54mm x 2"	1	38338	65.94

**Chrome plated – S13CP / 6092G**

12mm x 1/2"	10	38654	19.21
15mm x 1/2"	10	38655	19.43

**S14/6090G**  
**Female Elbow**  
Press-fit x parallel female thread



SIZE	BOX QTY	CODE	£ EACH
12mm x 3/8"	5	38346	9.86
12mm x 1/2"	5	38345	9.60
15mm x 3/8"	5	38347	9.97
15mm x 1/2"	10	38351	9.36
15mm x 3/4"	5	38344	12.47
18mm x 1/2"	5	38348	13.51
18mm x 3/4"	5	38349	13.51
22mm x 1/2"	5	38350	11.09
22mm x 3/4"	5	38353	13.77
28mm x 1"	5	38354	22.78
35mm x 1 1/4"	5	38355	29.42
42mm x 1 1/2"	1	38356	40.04
54mm x 2"	1	38357	58.89

**Chrome plated – S14CP / 6090G**

12mm x 3/8"	5	38659	17.25
15mm x 1/2"	10	38660	16.38

**XPress Copper Fittings (contd)**

**S15/6472G  
Backplate Elbow**

Press-fit x BSP parallel female thread



SIZE	BOX QTY	CODE	£ EACH
12mm x 1/2"	5	38397	10.03
15mm x 3/8"	10	38396	10.03
15mm x 1/2"	10	38400	8.87
18mm x 1/2"	5	38398	19.38
22mm x 3/4"	5	38401	19.50

**Chrome plated – S15CP / 6472G**

12mm x 1/2"	5	38665	17.55
15mm x 1/2"	10	38666	15.51

**S15L/6472L  
Backplate Elbow (long pattern)**

Press-fit x BSP parallel female thread



SIZE	BOX QTY	CODE	£ EACH
15mm x 1/2"	5	38399	21.03

**S19/7005  
90° Bend**

Male ends for insertion into fittings



SIZE	BOX QTY	CODE	£ EACH
15mm	20	38390	7.60
18mm	20	38391	8.19
22mm	20	38392	10.90
28mm	20	38393	18.23

**S21/7041  
Obtuse Elbow**

Press-fit x press-fit



SIZE	BOX QTY	CODE	£ EACH
12mm	10	38411	2.35
15mm	10	38410	2.52
18mm	5	38413	3.07
22mm	10	38412	3.46
28mm	5	38414	10.41
35mm	5	38416	14.85
42mm	1	38417	24.70
54mm	1	38418	35.12
67mm	1	38419	81.83
76mm	1	38420	101.39
108mm	1	38421	159.09

**Chrome plated – S21CP / 7041**

12mm	10	38667	4.13
15mm	10	38668	4.41

**S21S/7040  
Obtuse Street Elbow**

Press-fit x male end for insertion into fitting



SIZE	BOX QTY	CODE	£ EACH
12mm	10	38402	1.95
15mm	10	38404	2.08
18mm	10	38403	2.52
22mm	10	38405	3.12
28mm	5	38406	10.84
35mm	5	38407	15.63
42mm	1	38408	24.78
54mm	1	38409	36.85
67mm	1	38430	94.10
76mm	1	38431	106.48
108mm	1	38432	159.09

**Chrome plated – S21SCP / 7040**

12mm	10	38671	3.43
15mm	10	38672	3.65

**S22/7086  
Partial Crossover**

Press-fit x male end for insertion into fitting



SIZE	BOX QTY	CODE	£ EACH
15mm	5	38435	8.35
18mm	5	38437	13.14
22mm	10	38436	14.63

**Chrome plated – S22CP / 7086**

15mm	10	38675	14.61
------	----	-------	-------

**S22S/7087  
Crossover**

Both ends male for insertion into fitting



SIZE	BOX QTY	CODE	£ EACH
15mm	10	38438	8.89
18mm	10	38434	14.05
22mm	10	38439	24.95

**S23/7085  
Full Crossover**

Press-fit x press-fit



SIZE	BOX QTY	CODE	£ EACH
15mm	10	38440	8.73
18mm	10	38442	13.62
22mm	10	38441	15.11

**Chrome plated – S23CP / 7085**

15mm	10	38677	15.27
------	----	-------	-------

**S24/7130  
Equal Tee**

Press-fit on all ends

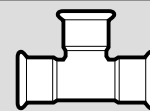

SIZE	BOX QTY	CODE	£ EACH
12mm	10	38472	4.50
15mm	10	38450	3.20
18mm	10	38451	5.27
22mm	10	38460	5.80
28mm	5	38462	10.59
35mm	5	38464	18.34
42mm	1	38466	36.20
54mm	1	38467	45.18
67mm	1	38468	134.51
76mm	1	38469	191.71
108mm	1	38471	260.65

**Chrome plated – S24CP / 7130**

12mm	10	38710	7.88
15mm	10	38711	5.69
22mm	10	38712	10.35

**S25/7130  
Tee, reduced branch**

Press-fit on all ends

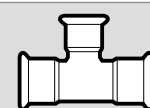

SIZE	BOX QTY	CODE	£ EACH
15 x 15 x 12mm	10	38488	4.69
18 x 18 x 12mm	10	38452	4.77
18 x 18 x 15mm	10	38454	4.77
22 x 22 x 12mm	10	38491	4.81
22 x 22 x 15mm	10	38490	4.72
22 x 22 x 18mm	10	38535	15.63
28 x 28 x 12mm	5	38493	20.30
28 x 28 x 15mm	5	38492	20.30
28 x 28 x 18mm	5	38538	12.53
28 x 28 x 22mm	5	38494	12.53
35 x 35 x 15mm	5	38496	16.57
35 x 35 x 22mm	5	38497	16.32
35 x 35 x 28mm	5	38498	18.18
42 x 42 x 15mm	1	38499	35.51
42 x 42 x 22mm	1	38500	33.73
42 x 42 x 28mm	1	38501	32.85
42 x 42 x 35mm	1	38502	32.85
54 x 54 x 22mm	1	38504	57.38
54 x 54 x 28mm	1	38505	57.38
54 x 54 x 35mm	1	38506	55.54
54 x 54 x 42mm	1	38507	55.54
67 x 67 x 28mm	1	38550	135.13
67 x 67 x 35mm	1	38560	135.05
67 x 67 x 42mm	1	38561	135.05
67 x 67 x 54mm	1	38562	131.41
76 x 76 x 22mm	1	38563	165.01
76 x 76 x 28mm	1	38564	165.01
76 x 76 x 35mm	1	38553	165.67
76 x 76 x 42mm	1	38551	165.67
76 x 76 x 54mm	1	38552	165.67
108 x 108 x 54mm	1	38555	220.48
108 x 108 x 67mm	1	38565	258.44
108 x 108 x 76mm	1	38557	259.23

**Chrome plated – S25CP / 7130**

15 x 15 x 12mm	10	38714	8.21
22 x 22 x 15mm	10	38715	8.41

**XPress Copper Fittings (contd)**

**S26/7130 Tee, one end reduced**  
Press-fit on all ends

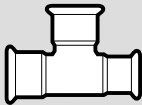

SIZE	BOX QTY	CODE	£ EACH
15 x 12 x 15mm	10	38508	4.69
18 x 15 x 18mm	10	38455	4.77
22 x 15 x 22mm	5	38510	9.74
22 x 18 x 22mm	10	38511	9.74
28 x 15 x 28mm	5	38512	9.80
28 x 22 x 28mm	5	38514	15.31
35 x 22 x 35mm	5	38517	21.14
35 x 28 x 35mm	5	38518	18.98

**Chrome plated – S26CP / 7130**

15 x 12 x 15mm	10	38719	8.21
----------------	----	-------	------

**S27/7130 Tee, one end and branch reduced**  
press-fit on all ends

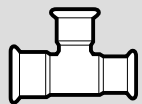

SIZE	BOX QTY	CODE	£ EACH
15 x 12 x 12mm	10	38527	4.69
18 x 15 x 15mm	10	38453	4.77
22 x 15 x 15mm	10	38530	8.81
22 x 15 x 18mm	10	38533	15.63
22 x 18 x 15mm	10	38531	8.81
22 x 18 x 18mm	10	38534	15.63
28 x 22 x 18mm	5	38529	15.31
28 x 22 x 15mm	5	38536	9.34
28 x 22 x 22mm	5	38532	15.63
35 x 22 x 22mm	5	38539	21.06
35 x 28 x 22mm	5	38541	21.52
35 x 28 x 28mm	5	38542	18.18
42 x 35 x 35mm	5	38546	27.67
54 x 42 x 42mm	1	38566	55.54

**Chrome plated – S27CP / 7130**

15 x 12 x 12mm	10	38723	8.21
----------------	----	-------	------

**S28/7130 Tee, both ends reduced**  
Press-fit on all ends

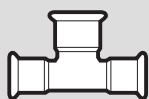

SIZE	BOX QTY	CODE	£ EACH
12 x 12 x 15mm	10	38447	10.34
15 x 15 x 18mm	10	38547	8.81
15 x 15 x 22mm	10	38545	8.81
22 x 22 x 28mm	5	38548	11.73
28 x 28 x 35mm	5	38549	21.06

**S30/6130G Female Branch Tee**  
Press-fit x BSP parallel female branch

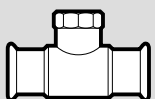

SIZE	BOX QTY	CODE	£ EACH
12 x 12mm x 1/2"	5	38584	9.19
15 x 15mm x 1/2"	5	38585	10.08
18 x 18mm x 1/2"	5	38586	22.43
22 x 22mm x 1/2"	5	38591	15.04
22 x 22mm x 3/4"	5	38587	20.58
28 x 28mm x 1/2"	5	38592	23.13
28 x 28mm x 3/4"	5	38593	24.92
35 x 35mm x 1/2"	5	38594	26.49
42 x 42mm x 1/2"	1	38596	31.64
54 x 54mm x 1/2"	1	38597	38.92
76 x 76mm x 1/2"	1	38190	168.49
108 x 108mm x 1/2"	1	38191	217.62

**Chrome plated – S30CP / 6130G**

15 x 15mm x 1/2"	10	38733	17.64
------------------	----	-------	-------

**S32/6130G Multi-port female branch tee**  
Press-fit x BSP parallel female branch

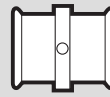

SIZE	BOX QTY	CODE	£ EACH
67mm x 1/2" (2 Ports)	1	38189	176.80
76mm x 1/2" (2 Ports)	1	38188	198.47
89mm x 3/4" (3 Ports)	1	38192	237.10
108mm x 3/4" (4 Ports)	1	38206	261.57

**S60 Stop End**  
Male end for insertion into fitting

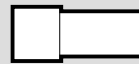

SIZE	BOX QTY	CODE	£ EACH
35mm	1	38686	15.31
42mm	1	38688	22.37
54mm	1	38690	28.56

**S61/7301 Stop End**  
For use with copper tube



SIZE	BOX QTY	CODE	£ EACH
12mm	10	38702	4.21
15mm	10	38695	4.08
18mm	1	38696	5.18
22mm	10	38697	4.75
28mm	5	38698	7.50
35mm	2	38699	12.90
42mm	1	38700	19.40
54mm	1	38701	23.35
67mm	1	38691	44.60
76mm	1	38692	48.84
108mm	1	38694	83.29

**Chrome plated – S61CP / 7301**

15mm	10	38739	7.15
------	----	-------	------

**S65F/6096G Press-fit female union elbow**  
Press-fit union x BSP parallel female

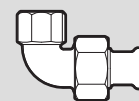

SIZE	BOX QTY	CODE	£ EACH
12mm x 1/2"	5	38790	21.14
15mm x 1/2"	5	38791	21.37
18mm x 1/2"	5	38792	21.99
18mm x 3/4"	5	38793	30.42
22mm x 3/4"	5	38794	31.75
22mm x 1"	5	38795	34.77
28mm x 1"	5	38796	35.25
35mm x 1 1/4"	5	38797	38.79
42mm x 1 1/2"	1	38798	51.76
54mm x 2"	1	38799	68.27

**S68FF/6359 Flat Faced Union Adaptor**  
Press-fit female x union nut

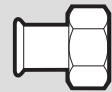

SIZE	BOX QTY	CODE	£ EACH
15mm x 3/4"	5	38235	16.28
18mm x 3/4"	5	38237	20.73
22mm x 1"	5	38238	21.91
28mm x 1 1/4"	5	38239	24.31
35mm x 1 1/2"	5	38242	37.18
42mm x 1 3/4"	5	38243	47.30

**Chrome plated – S68FFCP / 6359**

15mm x 3/4"	5	38742	28.47
-------------	---	-------	-------

**S69/6331G Straight Male Union Connector**  
Press-fit x BSP taper male thread

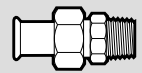

SIZE	BOX QTY	CODE	£ EACH
12mm x 3/8"	5	38807	20.87
12mm x 1/2"	5	38808	20.87
15mm x 1/2"	5	38813	21.10
15mm x 3/4"	5	38809	21.08
18mm x 1/2"	5	38810	21.69
18mm x 3/4"	5	38811	30.00
22mm x 1/2"	5	38812	34.34
22mm x 3/4"	5	38814	31.24
22mm x 1"	5	38815	34.34
28mm x 3/4"	5	38820	33.47
28mm x 1"	5	38816	34.71
35mm x 1 1/4"	5	38817	38.20
42mm x 1 1/2"	1	38818	50.89
54mm x 2"	1	38819	67.10

**S69F/6330G Straight Female Union Connector**  
Press-fit x BSP parallel female thread

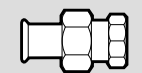

SIZE	BOX QTY	CODE	£ EACH
12mm x 1/2"	5	38828	20.87
15mm x 1/2"	5	38833	21.10
15mm x 3/4"	5	38829	29.29
18mm x 1/2"	5	38830	30.30
18mm x 3/4"	5	38831	31.10
22mm x 3/4"	5	38834	31.24
22mm x 1"	5	38832	31.24
28mm x 1"	5	38835	34.71
35mm x 1 1/4"	5	38836	38.20
42mm x 1 1/2"	1	38837	50.89
54mm x 2"	1	38838	67.10

**Stainless Steel  
316 System Tube**

**SS610  
Stainless Steel  
316 System Tube**  
6 metre lengths

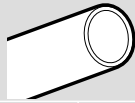

SIZE	BOX QTY	CODE	£ MTR
15 x 0.6mm	60	25010	9.26
18 x 0.6mm	60	25012	11.06
22 x 0.6mm	30	25014	14.60
28 x 0.8mm	30	25016	18.59
35 x 1.0mm	6	25018	27.87
42 x 1.0mm	6	25020	33.50
54 x 1.0mm	6	25022	42.19

**SS620  
Stainless Steel  
316 System Tube**  
6 metre lengths

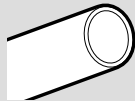

SIZE	BOX QTY	CODE	£ MTR
76 x 2.0mm	6	25026	87.57
89 x 2.0mm	6	25028	100.18
108 x 2.0mm	6	25030	120.74

**XPress Stainless Fittings**

**SS1  
Straight Coupling**  
Press-fit x press-fit

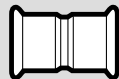

SIZE	BOX QTY	CODE	£ EACH
15mm	10	11694	5.83
18mm	10	11695	6.29
22mm	10	11696	7.34
28mm	10	11697	8.25
35mm	10	11698	10.27
42mm	4	11699	14.01
54mm	4	11700	16.85
76mm	4	20415	83.28
89mm	4	20416	95.18
108mm	2	20417	120.98

**SS1FMF  
Composite Flange**  
Press-fit x metric flange  
Female press-fit socket with steel  
flange. Outer flange to BS 4504  
type 133, PN 16 rated



SIZE	BOX QTY	CODE	£ EACH
42mm x DN40 (1½") (4 holes)	1	11680	112.04
54mm x DN50 (2") (4 holes)	1	11681	138.13
76mm x DN65 (2½") (4 holes)	1	20412	218.27
89mm x DN80 (3") (8 holes)	1	20413	259.35
108mm DN100 (4") (8 holes)	1	20414	307.87

**XPress Stainless Fittings (contd)**

**SS1 Slip  
Straight coupling  
slip pattern**  
Press-fit x press-fit

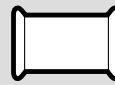

SIZE	BOX QTY	CODE	£ EACH
15mm	10	11728	9.68
18mm	10	11730	11.06
22mm	10	11729	11.50
28mm	10	11731	13.31
35mm	10	11732	14.87
42mm	4	11733	17.33
54mm	4	11734	22.13
76mm	2	20428	122.99
89mm	2	20429	138.86
108mm	2	20430	166.59

**SS2  
Straight Female Connector**  
Press-fit x BSP parallel  
female thread

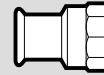

SIZE	BOX QTY	CODE	£ EACH
15mm x ½"	10	11641	11.94
18mm x ½"	10	11643	12.61
18mm x ¾"	10	11644	13.18
22mm x ½"	10	11646	13.46
22mm x ¾"	10	11647	15.83
28mm x 1"	10	11648	24.58
35mm x 1¼"	10	11653	26.89
42mm x 1½"	4	11654	41.38
54mm x 2"	4	11657	61.91

**SS3  
Straight Male Connector**  
Press-fit x BSP taper male thread

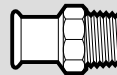

SIZE	BOX QTY	CODE	£ EACH
15mm x ½"	10	11658	11.10
18mm x ½"	10	11660	12.21
18mm x ¾"	10	11661	12.08
22mm x ¾"	10	11664	13.83
28mm x 1"	10	11665	17.49
35mm x 1¼"	5	11670	25.61
42mm x 1½"	4	11671	37.33
54mm x 2"	4	11674	50.17

**SS6  
Reducer**  
Larger end male for insertion  
into fitting x press-fit

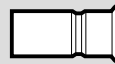

SIZE	BOX QTY	CODE	£ EACH
18 x 15mm	10	11712	6.29
22 x 15mm	10	11713	6.94
22 x 18mm	10	11714	7.21
28 x 15mm	10	11715	7.86
28 x 18mm	10	11716	8.01
28 x 22mm	10	11717	8.15
35 x 18mm	10	11718	30.69
35 x 22mm	5	11719	9.93
35 x 28mm	5	11720	12.31
42 x 28mm	5	11722	33.10
42 x 35mm	4	11723	12.98
54 x 22mm	4	11724	33.68
54 x 28mm	4	11725	36.63
54 x 35mm	4	11726	38.30
54 x 42mm	4	11727	14.84
76 x 54mm	4	20422	71.42
89 x 54mm	4	20423	77.08
89 x 76mm	4	20424	105.13
108 x 54mm	2	20425	81.05
108 x 76mm	2	20426	109.11
108 x 89mm	2	20427	120.98

**SS12  
Elbow**  
Press-fit x press-fit



SIZE	BOX QTY	CODE	£ EACH
15mm	10	11620	8.34
18mm	10	11621	9.57
22mm	10	11622	11.66
28mm	10	11623	14.71
35mm	10	11624	23.13
42mm	2	11625	38.63
54mm	2	11626	53.35
76mm	2	20406	128.88
89mm	2	20407	156.65
108mm	2	20408	214.20

**SS12S  
Street Elbow**  
Press-fit x male end for  
insertion into fitting

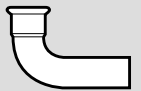

SIZE	BOX QTY	CODE	£ EACH
15mm	10	11634	8.17
18mm	10	11635	9.33
22mm	10	11636	11.31
28mm	10	11637	14.13
35mm	10	11638	22.70
42mm	2	11639	36.81
54mm	2	11640	52.98
76mm	2	20409	128.88
89mm	2	20410	156.65
108mm	2	20411	214.20

**SS13  
Male Elbow**  
Press-fit x BSP taper  
male thread

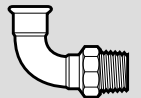

SIZE	BOX QTY	CODE	£ EACH
15mm x ½"	10	11687	15.29
18mm x ½"	10	11688	16.47
22mm x ¾"	10	11689	21.08
28mm x 1"	10	11690	26.89
35mm x 1¼"	10	11691	38.50
42mm x 1½"	2	11692	68.08
54mm x 2"	2	11693	87.01

**SS14  
Female Elbow**  
Stainless x parallel  
female thread



SIZE	BOX QTY	CODE	£ EACH
15mm x ½"	10	11682	17.48
22mm x ¾"	10	11684	23.49
28mm x 1"	10	11685	30.47
35mm x 1¼"	10	11686	51.99

**SS19S  
30° bend**  
Press-fit x press-fit



SIZE	BOX QTY	CODE	£ EACH
35mm	5	11795	47.34
42mm	2	11796	64.25
54mm	2	11797	81.15

**XPress Stainless Fittings (contd)**

**SS21  
Obtuse Elbow**  
Press-fit x press-fit



SIZE	BOX QTY	CODE	£ EACH
15mm	10	11604	11.31
18mm	10	11605	12.05
22mm	10	11606	14.07
28mm	10	11607	16.36
35mm	5	11608	19.20
42mm	2	11609	30.91
54mm	2	11610	40.14
76mm	2	20400	122.99
89mm	2	20401	146.74
108mm	2	20402	200.32

**SS215  
Obtuse Street Elbow**  
Press-fit x male end for insertion into fitting



SIZE	BOX QTY	CODE	£ EACH
15mm	10	11611	11.10
18mm	10	11612	11.81
22mm	10	11613	13.61
28mm	10	11614	15.93
35mm	4	11615	18.13
42mm	2	11616	29.24
54mm	2	11617	38.05
76mm	2	20403	113.02
89mm	2	20404	134.88
108mm	2	20405	184.47

**SS24  
Equal Tee**  
Press-fit on all ends

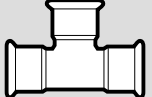

SIZE	BOX QTY	CODE	£ EACH
15mm	10	11735	13.66
18mm	10	11737	15.55
22mm	10	11740	16.78
28mm	10	11744	19.59
35mm	10	11749	24.82
42mm	4	11753	35.22
54mm	2	11758	42.17
76mm	2	20431	232.05
89mm	2	20432	253.85
108mm	2	20433	313.36

**SS25  
Tee, reduced branch**  
Press-fit on all ends



SIZE	BOX QTY	CODE	£ EACH
18 x 18 x 15mm	10	11736	13.53
22 x 22 x 15mm	10	11738	14.34
22 x 22 x 18mm	10	11739	14.81
28 x 28 x 15mm	10	11741	17.38
28 x 28 x 18mm	10	11742	17.84
28 x 28 x 22mm	10	11743	18.81
35 x 35 x 15mm	10	11745	21.47
35 x 35 x 18mm	10	11746	21.79
35 x 35 x 22mm	10	11747	22.31
35 x 35 x 28mm	10	11748	23.28
42 x 42 x 22mm	4	11750	31.97
42 x 42 x 28mm	4	11751	33.10
42 x 42 x 35mm	4	11752	34.09
54 x 54 x 22mm	2	11754	36.23
54 x 54 x 28mm	2	11755	37.25
54 x 54 x 35mm	2	11756	38.50
54 x 54 x 42mm	2	11757	39.61
76 x 76 x 22mm	2	20434	174.56
76 x 76 x 28mm	2	20435	188.40
76 x 76 x 35mm	2	20436	202.27
76 x 76 x 42mm	2	20437	218.18
76 x 76 x 54mm	2	20438	232.05
89 x 89 x 22mm	2	20439	184.47
89 x 89 x 28mm	2	20440	197.91
89 x 89 x 35mm	2	20441	212.18
89 x 89 x 42mm	2	20442	228.08
89 x 89 x 54mm	2	20443	237.98
89 x 89 x 76mm	2	20444	253.85
108 x 108 x 22mm	2	20445	196.36
108 x 108 x 28mm	2	20446	208.22
108 x 108 x 35mm	2	20447	228.08
108 x 108 x 42mm	2	20448	237.98
108 x 108 x 54mm	2	20449	257.86
108 x 108 x 76mm	2	20450	271.73
108 x 108 x 89mm	2	20451	311.40

**SS30  
Female Branch Tee**  
Press-fit x BSP parallel female branch

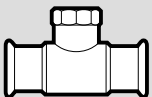

SIZE	BOX QTY	CODE	£ EACH
15 x 15mm x 1/2"	10	11759	14.94
18 x 18mm x 1/2"	10	11760	15.07
22 x 22mm x 1/2"	10	11762	16.38
22 x 22mm x 3/4"	10	11763	18.33
28 x 28mm x 1/2"	10	11765	18.05
28 x 28mm x 3/4"	10	11766	21.37
35 x 35mm x 1/2"	10	11767	21.74
35 x 35mm x 3/4"	10	11768	26.92
42 x 42mm x 1/2"	4	11769	26.50
42 x 42mm x 3/4"	4	11770	29.57
54 x 54mm x 1/2"	2	11771	31.50
54 x 54mm x 3/4"	2	11773	34.55
54 x 54mm x 2"	2	11772	68.44
76 x 76mm x 3/4"	2	20452	189.89
76 x 76mm x 2"	2	20453	209.93
89 x 89mm x 3/4"	2	20454	206.34
89 x 89mm x 2"	2	20455	219.12
108 x 108mm x 3/4"	2	20456	248.27
108 x 108mm x 2"	2	20457	264.76

**SS61  
Stop End**  
For use with copper tube



SIZE	BOX QTY	CODE	£ EACH
15mm	20	11701	5.55
18mm	20	11702	5.82
22mm	10	11703	6.45
28mm	10	11704	9.12
35mm	5	11705	10.55
42mm	4	11706	14.81
54mm	4	11707	17.15
76mm	2	20418	25.33
89mm	2	20419	32.52
108mm	2	20420	38.56

**SS69  
Straight Male Union Connector**  
Press-fit x BSP taper male thread

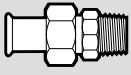

SIZE	BOX QTY	CODE	£ EACH
15mm x 1/2"	10	11774	24.64
18mm x 1/2"	10	11776	27.23
22mm x 3/4"	10	11779	36.52
28mm x 1"	10	11781	48.64
35mm x 1 1/4"	4	11782	62.06
42mm x 1 1/2"	4	11783	71.77
54mm x 2"	4	11784	124.08

**SS69F  
Straight Female Union Connector**  
Press-fit x BSP parallel female thread

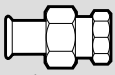

SIZE	BOX QTY	CODE	£ EACH
15mm x 1/2"	10	11785	24.64
18mm x 1/2"	10	11787	27.23
22mm x 3/4"	10	11789	36.52
28mm x 1"	10	11791	48.64
35mm x 1 1/4"	4	11792	62.06
42mm x 1 1/2"	4	11793	71.77
54mm x 2"	4	11794	124.08

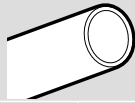
**Carbon Steel System Tube**
**SC640  
Galvanised Carbon Steel  
System Tube**  
6 metre lengths

SIZE	BOX QTY	CODE	£ MTR
15 x 1.2mm	6	25080	2.85
18 x 1.2mm	6	25081	3.41
22 x 1.5mm	6	25082	4.55
28 x 1.5mm	6	25083	6.42
35 x 1.5mm	6	25084	8.29
42 x 1.5mm	6	25085	11.33
54 x 1.5mm	6	25086	14.70
67 x 1.5mm	6	25090	20.59
76 x 2.0mm	6	25087	32.43
89 x 2.0mm	6	25088	36.69
108 x 2.0mm	6	25089	42.85

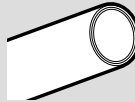
**SC660  
Plastic Coated Galvanised  
Carbon Steel System Tube**  
6 metre lengths  
Wall thickness dimensions  
include plastic coating of 1mm thickness

SIZE	BOX QTY	CODE	£ MTR
15 x 2.2mm	6	25060	4.17
18 x 2.2mm	6	25061	4.60
22 x 2.5mm	6	25062	6.02
28 x 2.5mm	6	25063	8.00
35 x 2.5mm	6	25064	9.99
42 x 2.5mm	6	25065	12.90
54 x 2.5mm	6	25066	16.56

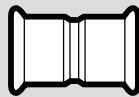
**XPress Carbon Fittings**
**SC1  
Straight Coupling**  
Press-fit x press-fit

SIZE	BOX QTY	CODE	£ EACH
15mm	10	20136	2.02
18mm	10	20137	2.13
22mm	10	20138	2.43
28mm	10	20139	3.08
35mm	10	20140	5.16
42mm	4	20141	6.90
54mm	4	20142	8.14
67mm	2	20662	30.46
76mm	4	20620	37.02
89mm	4	20621	47.8
108mm	2	20622	65.77

**XPress Carbon Fittings (contd)**
**SC1FMF  
Composite Flange**  
Press-fit x metric flange  
Female press-fit socket with carbon  
steel flange. Outer flange to  
BS 4504, type 133, PN 16 rated

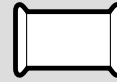

SIZE	BOX QTY	CODE	£ EACH
67mm x DN65 (2½") (4 holes)	1	20685	86.46
76mm x DN65 (2½") (4 holes)	1	20659	139.54
89mm x DN80 (3") (8 holes)	1	20660	165.75
108mm x DN65 (4") (8 holes)	1	20661	196.78

**SC1 Slip  
Straight Coupling**  
Slip Pattern  
Press-fit x press-fit

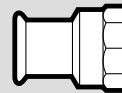
SIZE	BOX QTY	CODE	£ EACH
15mm	10	20144	2.31
18mm	10	20145	2.67
22mm	10	20146	2.95
28mm	10	20147	3.71
35mm	10	20148	8.00
42mm	4	20149	8.69
54mm	4	20150	10.36
67mm	2	20663	36.46
76mm	2	20623	78.56
89mm	2	20624	88.70
108mm	2	20625	106.47

**SC2  
Straight Female Connector**  
Press-fit x BSP parallel female  
thread

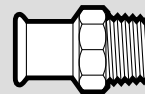
SIZE	BOX QTY	CODE	£ EACH
15mm x ½"	10	20237	6.26
18mm x ½"	10	20238	6.30
18mm x ¾"	10	20239	7.50
22mm x ¾"	10	20240	7.50
28mm x 1"	10	20241	9.51

**SC3  
Straight Male Connector**  
Press-fit x BSP taper  
male thread

SIZE	BOX QTY	CODE	£ EACH
15mm x ⅜"	10	20227	6.26
15mm x ½"	10	20228	6.26
18mm x ½"	10	20229	6.47
18mm x ¾"	10	20230	7.50
22mm x ¾"	10	20231	7.50
28mm x ¾"	10	20236	9.51
28mm x 1"	10	20232	9.51
35mm x 1¼"	10	20233	12.20
42mm x 1½"	4	20234	13.61
54mm x 2"	4	20235	21.12
67mm x 2½"	2	20664	84.79

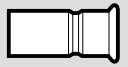
**SC6  
Reducer**  
Larger end male for insertion  
into fitting x press-fit

SIZE	BOX QTY	CODE	£ EACH
18 x 15mm	10	20213	1.85
22 x 15mm	10	20215	1.85
22 x 18mm	10	20216	2.01
28 x 15mm	10	20217	2.43
28 x 18mm	10	20218	2.43
28 x 22mm	10	20219	2.55
35 x 22mm	10	20220	2.84
35 x 28mm	10	20221	3.05
42 x 35mm	4	20222	6.61
54 x 22mm	4	20223	19.10
54 x 28mm	4	20224	19.23
54 x 35mm	4	20226	19.71
54 x 42mm	4	20225	20.22
67 x 28mm	2	20665	31.84
67 x 35mm	2	20666	29.76
67 x 42mm	2	20667	29.98
67 x 54mm	2	20668	31.80
76 x 54mm	4	20639	42.72
76 x 67mm	2	20669	33.78
89 x 54mm	4	20640	51.97
89 x 67mm	2	20670	51.05
89 x 76mm	4	20641	66.69
108 x 67mm	2	20671	65.22
108 x 76mm	2	20642	69.13
108 x 89mm	2	20643	77.30

**SC12  
Elbow**  
Press-fit x press-fit

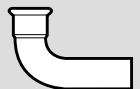

SIZE	BOX QTY	CODE	£ EACH
15mm	10	20155	2.93
18mm	10	20156	3.41
22mm	10	20157	3.82
28mm	10	20158	5.22
35mm	10	20159	13.04
42mm	2	20160	20.88
54mm	2	20161	24.95
67mm	1	20672	51.40
76mm	2	20626	77.35
89mm	2	20627	97.71
108mm	2	20628	133.94

**SC12S  
Street Elbow**  
Press-fit x male end for  
insertion into fitting

SIZE	BOX QTY	CODE	£ EACH
15mm	10	20163	2.93
18mm	10	20164	3.41
22mm	10	20165	3.82
28mm	10	20166	5.22
35mm	10	20167	13.04
42mm	2	20168	20.88
54mm	2	20169	24.95
67mm	1	20673	46.77
76mm	2	20629	82.37
89mm	2	20630	100.17
108mm	2	20631	136.88

**XPRESS Carbon Fittings (contd)**

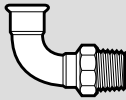
**SC13  
Male Elbow**  
Press-fit x BSP taper  
male thread



SIZE	BOX QTY	CODE	£ EACH
15mm x 3/8"	10	20198	7.27
15mm x 1/2"	10	20199	7.58
18mm x 1/2"	10	20200	8.24
22mm x 3/4"	10	20201	10.08
28mm x 1"	10	20202	12.33
35mm x 1 1/4"	10	20206	18.70
42mm x 1 1/2"	4	20204	31.28
54mm x 2"	2	20205	46.34

**SC21  
Obtuse Elbow**  
Press-fit x press-fit



SIZE	BOX QTY	CODE	£ EACH
15mm	10	20170	3.47
18mm	10	20171	3.66
22mm	10	20172	3.86
28mm	10	20173	5.25
35mm	10	20174	10.34
42mm	4	20175	12.97
54mm	2	20176	14.66
67mm	1	20674	49.28
76mm	2	20632	65.39
89mm	2	20633	83.48
108mm	2	20634	119.96

**SC21S  
Obtuse Street Elbow**  
Press-fit x male end for  
insertion into fitting



SIZE	BOX QTY	CODE	£ EACH
15mm	10	20177	3.17
18mm	10	20178	3.24
22mm	10	20179	3.48
28mm	10	20180	5.25
35mm	10	20181	9.51
42mm	4	20182	12.72
54mm	2	20183	14.51
67mm	1	20675	41.34
76mm	2	20635	72.24
89mm	2	20636	86.25
108mm	2	20637	117.95

**SC22S  
Partial Crossover**  
Both ends male for  
insertion into fitting



SIZE	BOX QTY	CODE	£ EACH
15mm	10	20193	3.18
18mm	10	20194	3.47
22mm	10	20195	3.96
28mm	10	20196	4.83

**SC24  
Equal Tee**  
Press-fit on all ends

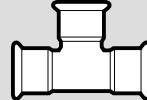

SIZE	BOX QTY	CODE	£ EACH
15mm	10	20249	5.55
18mm	10	20250	5.98
22mm	10	20251	6.43
28mm	10	20252	8.60
35mm	10	20253	13.41
42mm	4	20254	19.82
54mm	2	20255	23.76
67mm	1	20676	94.51
76mm	2	20644	138.42
89mm	2	20645	160.01
108mm	2	20646	194.78

**SC25  
Tee, reduced branch**  
Press-fit on all ends

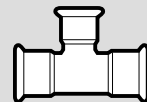

SIZE	BOX QTY	CODE	£ EACH
18 x 18 x 15mm	10	20258	5.98
22 x 22 x 15mm	10	20260	6.30
22 x 22 x 18mm	10	20261	6.43
28 x 28 x 15mm	10	20262	8.52
28 x 28 x 18mm	10	20263	8.83
28 x 28 x 22mm	10	20264	9.25
35 x 35 x 15mm	10	20265	12.49
35 x 35 x 18mm	10	20266	13.28
35 x 35 x 22mm	10	20267	13.51
35 x 35 x 28mm	10	20268	13.71
42 x 42 x 22mm	4	20269	18.10
42 x 42 x 28mm	4	20270	18.76
42 x 42 x 35mm	4	20271	18.31
54 x 54 x 22mm	2	20272	21.56
54 x 54 x 28mm	2	20273	21.99
54 x 54 x 35mm	2	20274	22.63
54 x 54 x 42mm	2	20275	23.74
67 x 67 x 28mm	1	20677	91.55
67 x 67 x 35mm	1	20678	92.40
67 x 67 x 42mm	1	20679	94.88
67 x 67 x 54mm	1	20680	96.71
76 x 76 x 22mm	2	20686	149.69
76 x 76 x 28mm	2	20687	149.69
76 x 76 x 35mm	2	20688	149.69
76 x 76 x 42mm	2	20689	149.69
76 x 76 x 54mm	2	20647	148.32
76 x 76 x 67mm	1	20681	139.93
89 x 89 x 22mm	2	20690	162.70
89 x 89 x 28mm	2	20691	162.70
89 x 89 x 35mm	2	20692	162.70
89 x 89 x 42mm	2	20693	162.70
89 x 89 x 54mm	2	20694	162.70
89 x 89 x 67mm	1	20682	153.06
89 x 89 x 76mm	2	20648	162.26
108 x 108 x 22mm	2	20695	182.22
108 x 108 x 28mm	2	20696	182.22
108 x 108 x 35mm	2	20697	195.24
108 x 108 x 42mm	2	20698	195.24
108 x 108 x 54mm	2	20699	195.24
108 x 108 x 76mm	2	20700	195.24
108 x 108 x 89mm	2	20649	199.07

**SC28  
Tee, both ends reduced**  
Press-fit on all ends

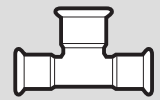

SIZE	BOX QTY	CODE	£ EACH
15 x 15 x 18mm	10	20709	9.85
15 x 15 x 22mm	10	20710	9.85
22 x 22 x 28mm	10	20712	10.04

**SC30  
Female Branch Tee**  
Press-fit x BSP parallel  
female branch

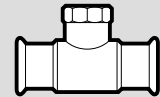

SIZE	BOX QTY	CODE	£ EACH
15 x 15mm x 1/2"	10	20281	7.94
18 x 18mm x 1/2"	10	20282	7.94
22 x 22mm x 1/2"	10	20283	8.74
28 x 28mm x 1/2"	10	20284	10.15
35 x 35mm x 1/2"	10	20285	13.86
42 x 42mm x 1/2"	4	20286	21.56
54 x 54mm x 1/2"	2	20287	23.74
67 x 67mm x 3/4"	1	20683	78.37
76 x 76mm x 3/4"	2	20650	121.41
89 x 89mm x 3/4"	2	20651	131.90
108 x 108mm x 3/4"	2	20652	158.69

**SC61  
Stop End**  
For use on  
carbon steel tube



SIZE	BOX QTY	CODE	£ EACH
15mm	20	20295	3.71
18mm	20	20296	3.96
22mm	10	20297	4.23
28mm	10	20298	6.26
35mm	5	20299	7.14
42mm	4	20300	11.18
54mm	4	20301	12.74
67mm	1	20684	30.31
76mm	2	20656	25.04
89mm	2	20657	32.14
108mm	2	20658	38.13

**SC69  
Straight Male Union  
Connector**  
Press-fit x BSP taper male thread

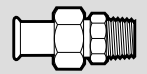

SIZE	BOX QTY	CODE	£ EACH
15mm x 1/2"	2	20302	16.62
15mm x 3/4"	10	20303	21.71
18mm x 1/2"	2	20304	17.92
22mm x 3/4"	2	20307	24.58
28mm x 1"	2	20309	27.33
35mm x 1 1/4"	2	20310	38.86
42mm x 1 1/2"	2	20311	57.48
54mm x 2"	2	20312	73.55

**SC69F  
Straight Female Union  
Connector**  
Press-fit x BSP parallel female thread

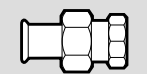

SIZE	BOX QTY	CODE	£ EACH
15mm x 1/2"	2	20313	16.62
15mm x 3/4"	10	20314	21.71
18mm x 1/2"	2	20315	17.92
22mm x 3/4"	2	20317	24.58
28mm x 1"	2	20319	27.33
35mm x 1 1/4"	1	20320	38.86
42mm x 1 1/2"	2	20321	57.48
54mm x 2"	2	20322	73.55

**XPress Copper Gas Fittings**
**SG1FMF/G7510**
**Composite Flange**

Female copper press-fit socket with powder coated steel outer flange to BS 4504 type 133, PN 16 rated



SIZE	BOX QTY	CODE	£ EACH
67mm DN65 (2½") (4 holes)	1	39281	158.67
76mm DN80 (3") (8 holes)	1	39282	189.40
108mm DN100 (4") (8 holes)	1	39284	224.92

**SG1FM/G7520**
**Composite Flange**

Press-fit x male end for insertion into fitting. Male copper spigot connector for insertion into press-fit socket with powder coated steel outer flange to BS 4504 type 133, PN 16 rated



SIZE	BOX QTY	CODE	£ EACH
67mm DN65 (2½") (4 holes)	1	39395	143.88
76mm DN80 (3") (8 holes)	1	39396	168.36
108mm DN100 (4") (8 holes)	1	39398	199.21

**SG1/G7270**
**Straight Coupling**

Press-fit x press-fit

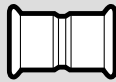

SIZE	BOX QTY	CODE	£ EACH
15mm	5	39700	2.44
18mm	5	39699	3.41
22mm	5	39701	3.77
28mm	5	39702	7.55
35mm	1	39703	9.57
42mm	1	39704	17.24
54mm	1	39705	22.00
67mm	1	39302	53.10
76mm	1	39303	69.82
108mm	1	39305	120.79

**SG1 Slip/G7270S**
**Straight Coupling**

Slip Pattern Press-fit x press-fit

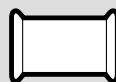

SIZE	BOX QTY	CODE	£ EACH
15mm	5	39710	4.86
18mm	5	39709	6.32
22mm	5	39711	7.55
28mm	5	39712	11.34
35mm	1	39713	14.39
42mm	1	39714	20.69
54mm	1	39715	26.38
67mm	1	39307	76.99
76mm	1	39308	93.67
108mm	1	39310	157.51

**SG2/G6270G**
**Straight Female Connector**

Press-fit x BSP parallel female thread

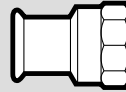

SIZE	BOX QTY	CODE	£ EACH
15mm x ½"	5	39720	9.81
15mm x ¾"	5	39721	10.29
18mm x ½"	5	39716	13.72
18mm x ¾"	5	39717	15.43
22mm x ½"	5	39722	15.16
22mm x ¾"	5	39723	12.92
28mm x 1"	5	39724	17.43
35mm x 1¼"	1	39725	34.02
42mm x 1½"	1	39726	48.65
54mm x 2"	1	39727	83.42

**SG3/G6243G**
**Straight Male Connector**

Press-fit x BSP taper male thread

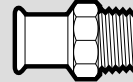

SIZE	BOX QTY	CODE	£ EACH
15mm x ½"	5	39730	8.86
15mm x ¾"	5	39731	6.47
18mm x ½"	5	39728	11.21
18mm x ¾"	5	39729	11.66
22mm x ½"	5	39732	7.73
22mm x ¾"	5	39733	12.74
22mm x 1"	5	39734	8.12
28mm x ¾"	5	39737	18.20
28mm x 1"	5	39735	17.02
28mm x 1¼"	5	39736	22.32
35mm x 1"	1	39738	30.30
35mm x 1¼"	1	39739	30.75
42mm x 1¼"	1	39741	45.77
42mm x 1½"	1	39740	41.22
54mm x 2"	1	39742	79.56
67mm x 2½"	1	39311	152.78
76mm x 3"	1	39313	264.37
108mm 4"	1	39315	457.75

**SG6/G7243**
**Reducer**

Larger end male for insertion into fitting x press-fit

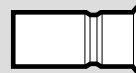

SIZE	BOX QTY	CODE	£ EACH
18 x 15mm	5	39761	2.51
22 x 15mm	5	39750	2.82
22 x 18mm	5	39762	2.64
28 x 15mm	5	39751	7.25
28 x 18mm	5	39763	7.39
28 x 22mm	5	39752	7.52
35 x 22mm	1	39753	9.00
35 x 28mm	1	39754	9.96
42 x 22mm	1	39755	15.54
42 x 28mm	1	39756	14.81
42 x 35mm	1	39757	14.81
54 x 35mm	1	39758	20.02
54 x 42mm	1	39759	20.02
67 x 28mm	1	39319	58.30
67 x 35mm	1	39320	58.30
67 x 42mm	1	39321	58.30
67 x 54mm	1	39322	70.57
76 x 35mm	1	39323	85.20
76 x 42mm	1	39324	85.20
76 x 54mm	1	39325	77.88
76 x 67mm	1	39327	94.53
108 x 42mm	1	39334	124.97
108 x 54mm	1	39335	104.97
108 x 67mm	1	39337	128.11
108 x 76mm	1	39338	112.90

**SG11/G6340**
**Union Coupling**

Press-fit x press-fit

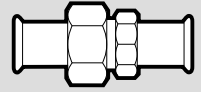

SIZE	BOX QTY	CODE	£ EACH
15mm	1	39770	35.38
18mm	1	39906	38.61
22mm	1	39771	40.06
28mm	1	39772	44.56
35mm	1	39773	49.47

**SG12/G7002A**
**Elbow**

Press-fit x press-fit



SIZE	BOX QTY	CODE	£ EACH
15mm	5	39780	2.61
18mm	5	39779	3.97
22mm	5	39781	4.37
28mm	5	39782	9.50
35mm	1	39783	18.93
42mm	1	39784	35.62
54mm	1	39785	49.38
67mm	1	39341	84.69
76mm	1	39342	133.01
108mm	1	39344	248.42

**SG12S/G7001A**
**Street Elbow**

Press-fit x male end for insertion into fitting

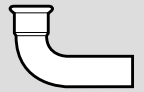

SIZE	BOX QTY	CODE	£ EACH
15mm	5	39790	2.64
18mm	5	39789	4.35
22mm	5	39791	4.60
28mm	5	39792	11.20
35mm	1	39793	19.56
42mm	1	39794	38.29
54mm	1	39795	51.46
67mm	1	39346	97.41
76mm	1	39347	142.7
108mm	1	39349	250.72

**SG13/G6092G**
**Male Elbow**

Press-fit x BSP taper male thread

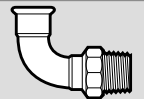

SIZE	BOX QTY	CODE	£ EACH
15mm x ½"	10	39800	13.87
18mm x ½"	5	39806	21.71
18mm x ¾"	5	39807	22.12
22mm x ¾"	5	39801	21.71
28mm x 1"	5	39802	33.25
35mm x 1¼"	1	39803	43.25
42mm x 1½"	1	39804	56.43
54mm x 2"	1	39805	82.46

**XPress Copper Gas Fittings (contd)**
**SG14/G6090G  
Female Elbow**

Press-fit x parallel female thread

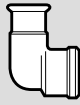

SIZE	BOX QTY	CODE	£ EACH
15mm x 1/2"	10	39810	11.75
15mm x 3/4"	10	39811	14.46
18mm x 1/2"	5	39808	17.22
18mm x 3/4"	5	39809	17.98
22mm x 1/2"	5	39813	12.81
22mm x 3/4"	5	39814	17.22
22mm x 1"	5	39812	21.90
28mm x 1"	5	39815	28.48
35mm x 1 1/4"	1	39816	36.74
42mm x 1 1/2"	1	39817	50.04
54mm x 2"	1	39818	73.58

**SG15/G6471G  
Backplate Elbow**

Press-fit x BSP parallel female thread

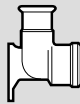

SIZE	BOX QTY	CODE	£ EACH
15mm x 1/2"	1	39820	15.81
18mm x 1/2"	1	39819	30.28
22mm x 3/4"	1	39821	39.13

**SG21/G7041  
Obtuse Elbow**

Press-fit x press-fit



SIZE	BOX QTY	CODE	£ EACH
15mm	5	39825	3.11
18mm	5	39823	4.06
22mm	5	39826	4.32
28mm	5	39827	12.99
35mm	1	39828	18.53
42mm	1	39829	30.93
54mm	1	39830	43.95
67mm	1	39351	102.3
76mm	1	39352	127.77
108mm	1	39354	197.65

**SG21S/G7040  
Obtuse Street Elbow**

Press-fit x press-fit



SIZE	BOX QTY	CODE	£ EACH
15mm	5	39835	2.61
18mm	5	39833	3.70
22mm	5	39836	3.92
28mm	5	39837	13.55
35mm	1	39838	19.50
42mm	1	39839	30.97
54mm	1	39840	46.07
67mm	1	39356	117.63
76mm	1	39357	133.01
108mm	1	39359	201.26

**SG22/G7086  
Partial Crossover**

Press-fit x male end for insertion into fitting



SIZE	BOX QTY	CODE	£ EACH
15mm	5	39841	10.44
18mm	5	39842	14.55
22mm	5	39843	15.68

**S22S/7087  
Crossover**

Both ends male for insertion into fitting



SIZE	BOX QTY	CODE	£ EACH
15mm	10	38438	8.89
18mm	10	38434	14.05
22mm	10	38439	24.95

**SG23/G7085  
Full Crossover**

Press-fit x press-fit



SIZE	BOX QTY	CODE	£ EACH
15mm	5	39844	10.91
18mm	5	39845	15.20
22mm	10	39846	16.39

**SG24/G7130  
Equal Tee**

Press-fit on all ends

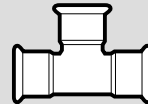

SIZE	BOX QTY	CODE	£ EACH
15mm	5	39850	4.18
18mm	5	39847	6.94
22mm	5	39851	7.55
28mm	5	39852	13.24
35mm	1	39853	22.92
42mm	1	39854	45.30
54mm	1	39855	56.52
67mm	1	39361	168.13
76mm	1	39362	239.32
108mm	1	39364	323.21

**SG25/G7130  
Tee, reduced branch**

Press-fit on all ends

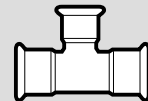

SIZE	BOX QTY	CODE	£ EACH
18 x 18 x 15mm	5	39856	5.68
22 x 22 x 15mm	5	39860	6.18
22 x 22 x 18mm	5	39868	6.18
28 x 28 x 15mm	5	39861	25.36
28 x 28 x 18mm	5	39857	25.36
28 x 28 x 22mm	5	39862	15.66
35 x 35 x 22mm	1	39863	20.41
35 x 35 x 28mm	1	39864	22.69
42 x 42 x 22mm	1	39869	40.48
42 x 42 x 28mm	1	39865	41.05
42 x 42 x 35mm	1	39866	41.05
54 x 54 x 22mm	1	39871	68.85
54 x 54 x 42mm	1	39867	69.41
67 x 67 x 28mm	1	39368	168.90
67 x 67 x 35mm	1	39369	168.83
67 x 67 x 42mm	1	39370	168.83
67 x 67 x 54mm	1	39371	164.28
76 x 76 x 22mm	1	39372	199.27
76 x 76 x 28mm	1	39373	199.27
76 x 76 x 35mm	1	39374	201.78
76 x 76 x 42mm	1	39375	201.78
76 x 76 x 54mm	1	39376	202.51
108 x 108 x 54mm	1	39382	259.63
108 x 108 x 67mm	1	39383	334.71
108 x 108 x 76mm	1	39384	334.71

**SG26/G7130  
Tee, one end reduced**

Press-fit on all ends

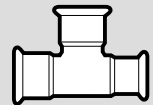

SIZE	BOX QTY	CODE	£ EACH
22 x 15 x 22mm	5	39870	12.13

**SG27/G7130  
Tee, one end and branch reduced**

Press-fit on all ends

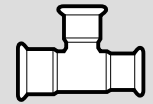

SIZE	BOX QTY	CODE	£ EACH
22 x 15 x 15mm	5	39875	11.02

**SG30/G6130G  
Female branch tee**

Press-fit x BSP parallel female branch

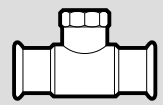

SIZE	BOX QTY	CODE	£ EACH
15mm x 1/2"	5	39890	12.77
18mm x 1/2"	5	39891	17.98
22mm x 1/2"	5	39892	18.80
22mm x 3/4"	5	39893	19.25
28mm x 1/2"	5	39894	28.91
28mm x 3/4"	5	39895	31.15
35mm x 1/2"	5	39896	31.77
35mm x 1"	1	38897	33.11
42mm x 1/2"	1	39898	45.75
54mm x 1/2"	1	39899	56.43
76mm x 1/2"	1	39386	210.60
108mm x 1/2"	1	39388	259.63

**SG61/G7301  
Stop End**

For use on copper tube



SIZE	BOX QTY	CODE	£ EACH
15mm	5	39880	5.11
18mm	5	39878	5.69
22mm	5	39881	5.93
28mm	5	39882	9.35
35mm	1	39883	16.12
42mm	1	39884	24.22
54mm	1	39885	29.21
67mm	1	39390	55.75
76mm	1	39391	61.05
108mm	1	39393	104.11

**SG68FF/G6359  
Flat Faced Union Adaptor**

Press-fit female x union nut

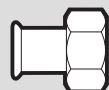

SIZE	BOX QTY	CODE	£ EACH
15mm x 7/8"	5	39910	21.92
22mm x 1 1/8"	5	39911	29.58
28mm x 1 3/8"	5	39912	32.81

### XPress Stainless Gas Fittings

**SSG1/7270**  
**Straight Coupling**  
Press-fit x press-fit

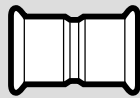

SIZE	BOX QTY	CODE	£ EACH
15mm	10	11800	6.64
22mm	10	11802	8.39
28mm	10	11803	9.44
35mm	10	11804	11.73
42mm	4	11805	16.02
54mm	4	11806	19.26

**SSG1S/7270S**  
**Straight Coupling, Slip Pattern**  
Press-fit x press-fit

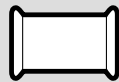

SIZE	BOX QTY	CODE	£ EACH
15mm	10	11808	11.06
22mm	10	11810	13.15
28mm	10	11811	15.24
35mm	10	11812	16.99
42mm	4	11813	19.80
54mm	3	11814	25.28

**SSG2/6270G**  
**Straight Female Connector**  
Press-fit x BSP parallel female thread

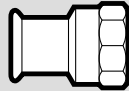

SIZE	BOX QTY	CODE	£ EACH
15mm x 1/2"	10	11928	13.66
22mm x 1/2"	10	11930	15.37
22mm x 3/4"	10	11931	18.08
28mm x 1"	10	11933	28.10
35mm x 1 1/4"	5	11934	30.72
42mm x 1 1/2"	4	11936	47.29
54mm x 2"	2	11937	70.74

**SSG3/6243G**  
**Straight Male Connector**  
Press-fit x BSP taper male thread

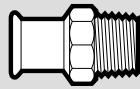

SIZE	BOX QTY	CODE	£ EACH
15mm x 1/2"	10	11914	12.68
22mm x 3/4"	10	11917	15.79
28mm x 1"	10	11919	19.97
35mm x 1 1/4"	10	11920	29.26
42mm x 1 1/2"	4	11923	42.67
54mm x 2"	2	11924	57.33

**SSG6/7243**  
**Reducer**  
Larger end male for insertion into fitting x press-fit

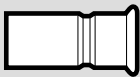

SIZE	BOX QTY	CODE	£ EACH
22 x 15mm	10	11849	7.94
28 x 15mm	10	11851	8.97
28 x 22mm	10	11853	9.28
35 x 22mm	10	11854	11.33
35 x 28mm	10	11855	14.07
42 x 28mm	5	11856	37.81
42 x 35mm	4	11857	14.84
54 x 28mm	4	11858	41.88
54 x 35mm	4	11859	43.80
54 x 42mm	4	11860	16.96

**SSG12/7002A**  
**Elbow**  
Press-fit x press-fit

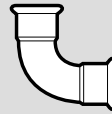

SIZE	BOX QTY	CODE	£ EACH
15mm	10	11816	9.52
22mm	10	11818	13.31
28mm	5	11819	16.82
35mm	5	11820	26.44
42mm	2	11821	44.14
54mm	2	11822	60.96

**SSG12S/7001A**  
**Street Elbow**  
Press-fit x male end for insertion into fitting

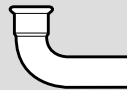

SIZE	BOX QTY	CODE	£ EACH
15mm	10	11824	9.32
22mm	10	11826	12.95
28mm	5	11827	16.15
35mm	5	11828	25.97
42mm	2	11829	42.08
54mm	2	11830	60.52

**SSG13/6092G**  
**Male Elbow**  
Press-fit x BSP taper male thread

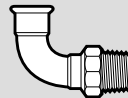

SIZE	BOX QTY	CODE	£ EACH
15mm x 1/2"	10	11940	17.48
22mm x 3/4"	10	11942	24.12
28mm x 1"	10	11943	30.72
35mm x 1 1/4"	10	11944	44.04

**SSG14/6090G**  
**Female Elbow**  
Press-fit x parallel female thread

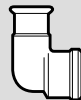

SIZE	BOX QTY	CODE	£ EACH
15mm x 1/2"	10	11950	19.96
22mm x 3/4"	10	11952	26.83
28mm x 1"	5	11953	34.85
35mm x 1 1/4"	5	11954	59.41

**SSG15/6472G**  
**Backplate Elbow**  
Press-fit x BSP parallel female thread



SIZE	BOX QTY	CODE	£ EACH
15mm x 1/2"	10	11957	18.57
22mm x 3/4"	10	11959	37.13

**SSG21/7041**  
**Obtuse Elbow**  
Press-fit x press-fit



SIZE	BOX QTY	CODE	£ EACH
15mm	10	11832	12.95
22mm	10	11834	16.07
28mm	5	11835	18.71
35mm	5	11836	21.96
42mm	4	11837	35.34
54mm	2	11838	45.90

**SSG21S/7040**  
**Obtuse Street Elbow**  
Press-fit x press-fit



SIZE	BOX QTY	CODE	£ EACH
15mm	10	11840	12.68
22mm	10	11842	15.54
28mm	5	11843	18.21
35mm	10	11844	20.91
42mm	4	11845	33.43
54mm	2	11846	43.48

**SSG24/7130**  
**Equal Tee**  
Press-fit on all ends

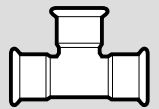

SIZE	BOX QTY	CODE	£ EACH
15mm	10	11865	15.61
22mm	10	11867	19.15
28mm	5	11868	22.41
35mm	5	11869	28.37
42mm	4	11870	40.27
54mm	2	11871	48.18

**SSG25/7130**  
**Tee, reduced branch**  
Press-fit on all ends

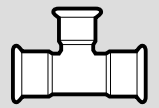

SIZE	BOX QTY	CODE	£ EACH
22 x 22 x 15mm	10	11873	16.38
28 x 28 x 15mm	10	11875	19.87
28 x 28 x 22mm	5	11877	21.49
35 x 35 x 15mm	5	11878	24.54
35 x 35 x 22mm	10	11880	25.50
35 x 35 x 28mm	5	11881	26.62
42 x 42 x 22mm	4	11882	36.55
42 x 42 x 28mm	4	11883	37.81
42 x 42 x 35mm	4	11884	38.97
54 x 54 x 22mm	2	11885	41.38
54 x 54 x 28mm	2	11886	42.59
54 x 54 x 35mm	2	11887	44.04
54 x 54 x 42mm	2	11888	45.26

**SSG30/6130G**  
**Female branch tee**  
Press-fit x BSP parallel female branch

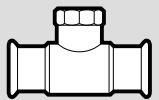

SIZE	BOX QTY	CODE	£ EACH
15 x 15mm x 1/2"	10	11900	17.05
22 x 22mm x 1/2"	10	11903	18.72
22 x 22mm x 3/4"	10	11904	20.96
28 x 28mm x 1/2"	10	11905	20.61
28 x 28mm x 3/4"	10	11906	24.42
35 x 35mm x 1/2"	10	11907	24.82
35 x 35mm x 3/4"	10	11908	30.78
42 x 42mm x 1/2"	4	11909	30.29
54 x 54mm x 1/2"	2	11910	36.02
54 x 54mm x 3/4"	2	11911	39.52
54 x 54mm x 2"	2	11912	78.24

**SSG61/7301**  
**Stop End**  
For use on copper tube



SIZE	BOX QTY	CODE	£ EACH
15mm	20	11980	6.32
22mm	10	11982	7.36
28mm	10	11983	10.41
35mm	10	11984	12.04
42mm	4	11985	16.91
54mm	4	11986	19.59

**XPress Solar**

**SR1/7270  
Straight Coupling**  
Press-fit x press-fit

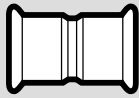

SIZE	BOX QTY	CODE	£ EACH
15mm	10	38010R	2.87
22mm	10	38020R	4.50
28mm	5	38030R	8.23
35mm	5	38032R	13.98
42mm	1	38034R	15.40
54mm	1	38035R	18.93

**SR1 Slip/7270S  
Straight Coupling Slip  
Pattern**  
Press-fit x press-fit

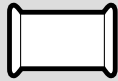

SIZE	BOX QTY	CODE	£ EACH
15mm	10	38044R	4.85
22mm	10	38045R	7.82
28mm	5	38046R	9.91
35mm	5	38047R	14.09
42mm	1	38048R	20.10
54mm	1	38049R	25.54

**SR2/6270G  
Straight Female Connector**  
Press-fit x BSP parallel  
female thread

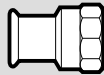

SIZE	BOX QTY	CODE	£ EACH
15mm x 1/2"	10	38090R	10.17
22mm x 3/4"	5	38092R	13.15
28mm x 1"	5	38093R	17.60
35mm x 1 1/4"	5	38094R	32.76
42mm x 1 1/2"	1	38095R	49.23
54mm x 2"	1	38096R	80.84

**SR3/6243G  
Straight Male Connector**  
Press-fit x BSP taper  
male thread

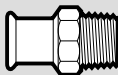

SIZE	BOX QTY	CODE	£ EACH
15mm x 1/2"	10	38114R	8.31
22mm x 3/4"	5	38116R	11.92
28mm x 1"	5	38118R	16.02
35mm x 1 1/4"	5	38119R	30.10
42mm x 1 1/2"	1	38120R	40.45
54mm x 2"	1	38121R	78.01

**SR6/7243  
Reducer**  
Larger end male for insertion  
into fitting x press-fit

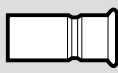

SIZE	BOX QTY	CODE	£ EACH
22 x 15mm	10	38200R	3.38
28 x 15mm	10	38202R	7.33
28 x 22mm	10	38204R	7.98
35 x 22mm	5	38207R	9.51
35 x 28mm	5	38208R	10.52
42 x 22mm	1	38210R	15.31
42 x 28mm	1	38211R	16.53
42 x 35mm	1	38212R	17.18
54 x 28mm	1	38215R	24.24
54 x 35mm	1	38216R	20.50
54 x 42mm	1	38217R	22.10

**SR11/6330  
Union Coupling**  
Press-fit x press-fit

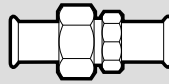

SIZE	BOX QTY	CODE	£ EACH
15mm	5	38180R	13.61
22mm	5	38181R	20.16
28mm	5	38182R	29.84
35mm	5	38183R	63.24
42mm	1	38184R	80.73
54mm	1	38185R	90.51

**SR12/7002A  
Elbow**  
Press-fit x press-fit



SIZE	BOX QTY	CODE	£ EACH
15mm	10	38280R	3.06
22mm	10	38290R	5.01
28mm	5	38300R	9.77
35mm	5	38302R	21.31
42mm	1	38304R	40.06
54mm	1	38306R	52.92

**SR12S/7001A  
Street Elbow**  
Press-fit x male end  
For insertion into fitting

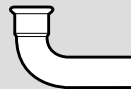

SIZE	BOX QTY	CODE	£ EACH
15mm	10	38318R	2.74
22mm	10	38320R	4.53
28mm	5	38322R	10.72
35mm	5	38324R	19.87
42mm	1	38325R	39.04
54mm	1	38326R	50.60

**SR13/6092G  
Male Elbow**  
Press-fit x BSP taper  
male thread

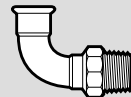

SIZE	BOX QTY	CODE	£ EACH
15mm x 1/2"	10	38333R	12.50
22mm x 3/4"	10	38334R	19.16
28mm x 1"	5	38335R	29.42
35mm x 1 1/4"	5	38336R	38.23
42mm x 1 1/2"	1	38337R	31.26
54mm x 2"	1	38338R	92.72

**SR14/6090G  
Female Elbow**  
Press-fit x parallel  
female thread



SIZE	BOX QTY	CODE	£ EACH
15mm x 1/2"	10	38351R	10.49
22mm x 3/4"	10	38353R	15.42
28mm x 1"	5	38354R	26.08
35mm x 1 1/4"	5	38355R	32.84
42mm x 1 1/2"	1	38356R	59.89
54mm x 2"	1	38357R	65.15

**SR15/6472G  
Backplate Elbow**  
Press-fit x BSP parallel  
female thread

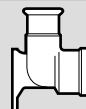

SIZE	BOX QTY	CODE	£ EACH
15mm x 1/2"	10	38400R	9.820
22mm x 3/4"	5	38401R	21.83

**SR21/7041  
Obtuse Elbow**  
Press-fit x press-fit



SIZE	BOX QTY	CODE	£ EACH
15mm	10	38410R	3.51
22mm	10	38412R	4.99
28mm	5	38414R	13.10
35mm	5	38416R	23.28
42mm	1	38417R	37.84
54mm	1	38418R	51.71

**SR21S/7040  
Obtuse Street Elbow**  
Press-fit x male end for  
insertion into fitting



SIZE	BOX QTY	CODE	£ EACH
15mm	10	38404R	2.66
22mm	10	38405R	4.04
28mm	5	38406R	12.55
35mm	5	38407R	21.05
42mm	1	38408R	31.87
54mm	1	38409R	47.81

**SR24/7130  
Equal Tee**  
Press-fit on all ends

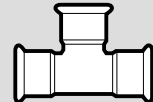

SIZE	BOX QTY	CODE	£ EACH
15mm	10	38450R	4.76
22mm	10	38460R	8.48
28mm	5	38462R	14.03
35mm	5	38464R	25.49
42mm	1	38466R	51.78
54mm	1	38467R	61.91

**SR25/7130  
Tee, reduced branch**  
Press-fit on all ends

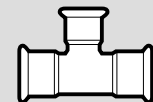

SIZE	BOX QTY	CODE	£ EACH
22 x 22 x 15mm	10	38490R	6.96
28 x 28 x 15mm	5	38492R	27.80
28 x 28 x 22mm	5	38494R	15.85
35 x 35 x 15mm	5	38496R	22.04
35 x 35 x 22mm	5	38497R	22.22
35 x 35 x 28mm	5	38498R	24.81
42 x 42 x 15mm	1	38499R	49.87
42 x 42 x 22mm	1	38500R	49.62
42 x 42 x 28mm	1	38501R	29.92
42 x 42 x 35mm	1	38502R	52.62
54 x 54 x 22mm	1	38504R	77.31
54 x 54 x 28mm	1	38505R	76.12
54 x 54 x 35mm	1	38506R	75.41
54 x 54 x 42mm	1	38507R	72.74

**SR26/7130  
Tee, one end reduced**  
Press-fit on all ends

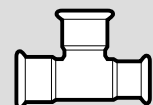

SIZE	BOX QTY	CODE	£ EACH
22 x 15 x 22mm	5	38510R	15.71
28 x 15 x 28mm	5	38512R	11.62
28 x 22 x 28mm	5	38514R	22.49
35 x 22 x 35mm	5	38517R	25.94
35 x 28 x 35mm	5	38518R	23.47

**XPress Solar (contd)**

**SR27/7130**  
**Tee, one end and**  
 branch reduced  
 press-fit on all ends



SIZE	BOX QTY	CODE	£ EACH
22 x 15 x 15mm	10	38530R	12.48
28 x 22 x 15mm	5	38536R	11.73
28 x 22 x 22mm	5	38532R	21.61
35 x 22 x 22mm	5	38539R	27.21
35 x 28 x 22mm	5	38541R	25.77
35 x 28 x 28mm	5	38542R	21.82

**SR28/7130**  
**Tee, both ends reduced**  
 Press-fit on all ends

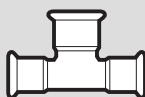

SIZE	BOX QTY	CODE	£ EACH
15 x 15 x 22mm	10	38545R	13.00

**SR30/6130G**  
**Female Branch Tee**  
 Press-fit x BSP parallel  
 female branch

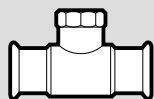

SIZE	BOX QTY	CODE	£ EACH
15 x 15mm x 1/2"	5	38585R	11.62
22 x 22mm x 1/2"	5	38591R	12.48
22 x 22mm x 3/4"	5	38587R	19.05
28 x 28mm x 1/2"	5	38592R	28.84
28 x 28mm x 3/4"	5	38593R	30.32
35 x 35mm x 1/2"	5	38594R	35.88
42 x 42mm x 1/2"	1	38596R	41.66

**SR61/7301**  
**Stop End**  
 For use with copper tube



SIZE	BOX QTY	CODE	£ EACH
15mm	10	38695R	4.92
22mm	10	38697R	5.52
28mm	5	38698R	9.29
35mm	2	38699R	15.79
42mm	1	38700R	24.85
54mm	1	38701R	186.25

**SR69/6331G**  
**Straight Male Union**  
**Connector**  
 Press-fit x BSP taper male thread

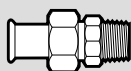

SIZE	BOX QTY	CODE	£ EACH
15mm x 1/2"	5	38813R	23.26
22mm x 3/4"	5	38814R	35.19
28mm x 1"	5	38816R	38.11
35mm x 1 1/4"	5	38817R	42.99
42mm x 1 1/2"	1	38818R	88.87
54mm x 2"	1	38819R	73.61

**SR69F/6330G**  
**Straight Female Union**  
**Connector**  
 Press-fit x BSP parallel female thread

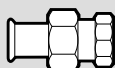

SIZE	BOX QTY	CODE	£ EACH
15mm x 1/2"	5	38833R	23.22
22mm x 3/4"	5	38834R	13.67
28mm x 1"	5	38835R	39.63
35mm x 1 1/4"	5	38836R	42.68
42mm x 1 1/2"	1	38837R	89.58
54mm x 2"	1	38838R	73.47

**Accessories**

**S100 Replacement 'O' Rings**  
For XPress Copper fittings only

SIZE	BOX QTY	CODE	£ EACH
15mm	20	39115	0.30
22mm	20	39122	0.38
28mm	20	39128	0.43
35mm	20	39135	0.44
42mm	20	39142	0.59
54mm	20	39154	0.65
67mm	5	39230	1.94
76mm	5	39231	2.76
108mm	5	39232	4.11

**S104 Flat Face Union Washer**

SIZE	BOX QTY	CODE	£ EACH
1/2"	10	38989	0.19
3/4"	10	38990	0.19
1"	10	38991	0.24
1 1/4"	10	38992	0.27
1 1/2"	10	38993	0.44
2"	10	38994	0.54
2 1/2"	10	38995	1.32

**SS100 Replacement 'O' Rings**  
For XPress Stainless fittings only

SIZE	BOX QTY	CODE	£ EACH
15mm	20	27000	0.28
18mm	20	27001	0.30
22mm	20	27002	0.35
28mm	20	27003	0.40
35mm	20	27004	0.41
42mm	20	27005	0.55
54mm	20	27006	0.60
76mm	5	27007	2.56
89mm	5	27008	3.25
108mm	5	27009	3.81

**SS106 Flat face union rubber washer Mk2**  
For use with XPress stainless and XPress carbon union fittings

SIZE	BOX QTY	CODE	£ EACH
15 to 18mm		27030	0.18
22mm		27031	0.39
28mm		27032	0.57
35mm		27033	0.78
42mm		27034	0.96
54mm		27035	1.76

**SV100 Viton 'O' Rings**  
For use on XPress Copper and XPress solar fittings

SIZE	BOX QTY	CODE	£ EACH
15mm	20	39100	0.30
22mm	20	39101	0.46
28mm	20	39102	0.56
35mm	20	39103	0.81
42mm	20	39104	1.33
54mm	20	39105	1.40
67mm*	20	39106	9.51

**SV105 Viton 'O' Rings**  
For use on XPress stainless and XPress carbon fittings

SIZE	BOX QTY	CODE	£ EACH
15mm	20	39080	1.22
18mm	20	39081	1.80
22mm	20	39082	1.87
28mm	20	39083	2.21
35mm	20	39084	2.45
42mm	20	39085	3.15
54mm	20	39086	3.38
76mm	20	39088	23.63
89mm	20	39089	29.57
108mm	20	39090	38.75

**S110 Depth Gauge**  
For with XPress Copper, XPress Stainless and XPress Carbon

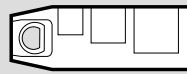

SIZE	BOX QTY	CODE	£ EACH
15 - 54mm	1	39160	13.67

**S115 Tube Stripper**  
For use with SC660 plastic coated carbon steel System tube



SIZE	BOX QTY	CODE	£ EACH
15mm	1	39260	66.40
18mm	1	39261	66.40
22mm	1	39262	77.98
28mm	1	39263	77.98
35 - 54mm	1	39264	94.94

**S120 Deburring Tool**



SIZE	BOX QTY	CODE	£ EACH
15 - 54mm	1	39168	184.16

**S122 Tube Preparation Kit**  
For copper only



SIZE	BOX QTY	CODE	£ EACH
35 - 54mm	1	39233	142.30

**S130 Silicone Lubricant**  
For lubricating tube and 'O' rings



SIZE	BOX QTY	CODE	£ EACH
100g tub	1	39219	6.76

**S135 Dri-slide Lubricant**  
For lubricating 42mm to 108mm press-fit jaws. Must not come into contact with 'O' rings

SIZE	BOX QTY	CODE	£ EACH
115ml	1	39169	11.47

**TA143 Internal swivel blade**  
Cobalt  
For use with TA147



SIZE	BOX QTY	CODE	£ EACH
All tube sizes	10	76200	Refer to Tectite price list

**TA144 Internal swivel blade**  
Carbide - BS2015  
For use with TA147



SIZE	BOX QTY	CODE	£ EACH
All tube sizes	10	76201	Refer to Tectite price list

**TA145 External chamfer bit**  
For use with TA146/148



SIZE	BOX QTY	CODE	£ EACH
15 - 22mm	1	76202	Refer to Tectite price list

**TA146 Rotodrive holder**  
For use with TA145/148



SIZE	BOX QTY	CODE	£ EACH
	1	76203	Refer to Tectite price list

**TA147 Noga 1000 handle**  
For use with TA143/144



SIZE	BOX QTY	CODE	£ EACH
	1	76208	Refer to Tectite price list

**TA148 Noga 3000 handle**  
For use with TA145/146



SIZE	BOX QTY	CODE	£ EACH
	1	76206	Refer to Tectite price list

**TA150 Noga deburring kit**  
Contains TA148/146/145

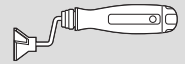

SIZE	BOX QTY	CODE	£ EACH
15 - 22mm	1	76207	Refer to Tectite price list

**TA155 Carbon cutter wheel**  
For use with Rems Cento



SIZE	BOX QTY	CODE	£ EACH
N/A	1	76250	Refer to Tectite price list



**Tools and jaws**

*To ensure you receive the appropriate XPress machine tool and compatible jaws for your requirements, please contact the Pegler Yorkshire technical sales help desk for advice, price and availability.*



Pegler Yorkshire

*Price list – 1st March 2011*



## 1. General

In these conditions, reference to the Company shall mean Pegler Yorkshire. All quotations are made and all orders are accepted subject to these conditions. All other terms, conditions or warranties whatsoever are excluded from the contract or any variation thereof unless expressly accepted by the Company in writing. In the event of a conflict between these conditions and the specific terms and conditions of quotation then the latter shall prevail.

## 2. Electronic Trading

- a) If the Company and Buyer agree that electronic trading between them shall be a basis for order processing and invoicing then the Standard Interchange Agreement (1st Edition March 1989) of the EDI Association shall be incorporated into the contract by reference subject to these conditions.
- b) Electronic orders shall be valid if all the information agreed between the Buyer and the Company as being required is properly set out in the agreed format and the order is transmitted by the Buyer to the Company by reference to the correct identification code and is received by the Company when collecting its electronic mail from the relevant system.
- c) Each valid electronic order will be deemed accepted by the Company unless the Company communicates rejection of the order to the Buyer by electronic or other means (including telephone) within 24 hours of receipt. Acceptance of an order shall constitute a contract for sale and purchase to which these conditions and the Standard Interchange Agreement shall prevail.
- d) If the Company and the Buyer agree that invoicing may be done by electronic mail, then payment will be due 30 days after the date of electronic invoice unless agreed otherwise.

## 3. Delivery

- a) Any date for delivery named by the Company is an estimate only and in no circumstances shall the failure of the Company to deliver on or before the named date either entitle the Buyer to rescind or terminate the contract or make the Company liable in any way for the consequences of any delay.
- b) Tube orders for XPress are sent on specialist carrier, and will be delivered separately to your normal orders. Tube Orders are carriage paid for orders of £1,500 nett and above. For orders below £1,500 carriage charges apply.

## 4. Export

Unless specifically stated otherwise in these conditions all trade terms not specifically covered by these conditions shall be interpreted in accordance with INCOTERMS current on the date of that order.

## 5. Warranty and Defective Goods

- a) Save as otherwise provided by the other conditions of these Conditions, sections 12 to 15 of the Sale of Goods Act 1979 are to be implied into this contract.
- b) The goods delivered under the Contract shall, where the Contract includes a specification, comply with the specification or, if there is no specification, shall be of normal industrial quality.
- c) The Buyer does not rely on any statement or representations other than those which have been made in writing by the Company.
- d) The Buyer must give the Company immediate written notice of any defect in the goods. Such goods shall be returned to the Company and if proved to have been defective at delivery as a result of faulty materials or workmanship, the Company shall at its option replace or repair such goods. Defects in quality or dimension in any delivery shall not be ground for cancellation of the remainder of the order.
- e) Save for any liability for death or personal injury caused by the Company's negligence, the Company's liability in connection with defective goods shall be limited to the repair or supply of a replacement for the defective goods, and the Company shall not be liable for any other loss or damage including, but not limited to loss of profit, labour costs, damage to property, wasted expenditure or cost of mitigation.

## 6. Data and Technical Information

The information contained in the advertising sales and technical literature issued by the Company may be relied upon to be accurate in the exact circumstances in which it is expressed. Any illustrations, performance details, examples of illustrations and methods of assembly and all other technical data in such literature are based on experience and upon trials under test conditions and are provided for general guidance only.

## 7. Claims For Damage, Shortage or Loss

No claim for damage in transit or shortage of delivery can be accepted unless, a separate notice in writing is given to the carrier concerned and to the Company within three days of receipt of the goods, followed by a complete claim in writing within five days of receipt of the goods. No claim for loss of goods in transit can be accepted unless a separate notice in writing is given to the carrier concerned and to the Company, and a complete claim in writing made within 21 days of the date of consignment. Where goods are accepted from the carrier concerned without being checked, the delivery book of the carrier must be signed "not examined". If a complaint is not made to the Company as herein provided, the products shall be deemed to be in all respects in accordance with the Contract, and the Buyer shall be bound to pay for the same accordingly.

## 8. Suspension of Deliveries

- a) Deliveries may be wholly or partially suspended by the company in the event of:-
  - i. Stoppage, delay or interruption caused to the business of the Company as a result of strikes, lockouts, trade disputes, breakdown, accident or any cause whatsoever beyond the reasonable control of the Company.
  - ii. Any default by the Buyer in making payment of any amounts owed to the Company under this and any other contracts between them.
- b) In the event of any hostilities (whether war is declared or not) in which Great Britain is involved, or in the event of national emergency, or if the Company's works should become either directly or indirectly engaged on Government orders as to prevent or delay work on other orders, the Company shall be entitled at any time, on notice to the Buyer, to make partial deliveries only or to determine the contract without prejudice in any case to rights accrued in respect of deliveries already made.

## 9. Determination of Contract

The Company shall have the right forthwith to determine this and/or any other Contract between the Buyer and the Company by written notice to the Buyer's last known address (without prejudice to any claim or right the Company might otherwise make or exercise) in any of the following events:-

- a) If the Buyer shall make default in or commit a breach of any contract with the Company; or
- b) If any distress or execution shall be levied upon the Buyer's property or assets; or
- c) If the Buyer shall make or offer to make any arrangements or composition with creditors, or commit any act of bankruptcy or become insolvent; or
- d) If any petition or receiving order in bankruptcy shall be presented or made against him; or
- e) If the buyer shall be a limited Company and become subject of any resolution or petition for winding up or administration; or
- f) If a receiver or manager of the Buyer's undertaking, property or assets or any part thereof shall be appointed.

## 10. Indemnity

The Buyer will indemnify the Company against all damages, penalties, costs and expenses to which the Company may become liable as a result of work done to the Buyer's instructions or which infringe any letters, patent or registered design or copyright or any other third party intellectual property rights.

## 11. Prices

The price payable for the goods shall unless otherwise agreed be the Company's list price current at the date of despatch. Such prices are inclusive of delivery to the Buyer's UK mainland delivery point but costs of delivery to any other destinations will be charged to the Buyer.

## 12. Risk and Title

- a) Risk shall pass to the Buyer so that the Buyer is responsible for all loss, damage or deterioration to the goods:
  - i. If the Company delivers the goods by its own transport at the time when the goods or a relevant part thereof arrive at the place of delivery; or
  - ii. In all other circumstances at the time when the goods, or a relevant part thereof leave the premises of the Company whether or not the Company arranges transport and (without prejudice to clause 7) where the goods are delivered by carrier, any claims for loss or damage in transit must be made by the Buyer against the carrier in accordance with the carrier's conditions.
- b) Title to the goods supplied under the contract shall only pass to the Buyer when payment in full for all goods supplied under this and all other contracts between the Company and the Buyer has been received by the Company.

The Company reserves the immediate right to possession of and at any time may recover all goods in respect of which title has not passed to the Buyer; the Company is hereby authorised by the Buyer to enter upon any premises where such goods are held by or on behalf of the Buyer and recover possession thereof.

- c) Until title to goods has been passed to the Buyer pursuant to these conditions it shall possess the goods as a Bailee at will of the Company, and the Buyer shall not be entitled to sell or otherwise deal in goods in respect of which title has not passed to the Buyer. If the Buyer acts in breach of these conditions then without prejudice to any other rights of the Company the Buyer shall have a fiduciary duty to account to the Company for the proceeds of any sale save to the extent that any such proceeds exceed the amounts owed to the Company under this and all other contracts between the Company and the Buyer.

## 13. Cancellation

Cancellation will only be accepted by the Company on condition that all costs and expenses incurred by the Company up to the time of cancellation and all loss of profits and other loss or damage suffered by the Company as a result of such cancellation will be paid forthwith by the Buyer to the Company.

## 14. Payment of Accounts

- a) Unless otherwise agreed by the Company in writing, payment shall be settled in full by the last working day of the month following the month in which the goods were despatched, or would have been despatched save for postponement otherwise than due to default on the part of the Company. The Company shall be entitled to submit its invoice on the same day as its delivery advice note or at any time thereafter, save that where delivery has been postponed at the request of or the default of the Buyer, then the Company may submit its invoice at any time after the goods are ready for delivery or would have been ready in the ordinary course but for the request or default as aforesaid.
- b) The Company reserves the right to charge interest at a rate up to 5% above Lloyds Bank Base Lending Rate ruling at the time payment is due if payment is not made in accordance with the terms agreed at the time the order is accepted.

## 15. VAT

The prices quoted are exclusive of VAT which will, if applicable, be added to the invoice at the rate then current.

## 16. Consumer Protection Act

In circumstances where the Company supplies parts or goods to the Buyer for incorporation with, or use ancillary to, any composite goods to be produced, manufactured, processed or supplied by the Buyer then:

- a) The Buyer shall forthwith on demand produce for inspection by the Company copies of all written instructions, information and warnings in relation to the said composite goods, provided nevertheless that such inspection or right to inspect shall not of itself constitute acceptance or approval on the part of the Company of such instructions, information, or warnings; and
- b) The Buyer shall indemnify, reimburse and compensate the Company for all losses and damages (including costs, expenses and charges for legal actions in which the Company may be involved) that the Company may incur in the event that any claim or claims are made against the Company pursuant to the Act relating to the said composite goods of the Buyer or parts or goods supplied hereunder in circumstances in which the parts or goods supplied by the Company was either:
  - i. Not the defective part of the said composite goods; or
  - ii. Was only rendered the defective part or became defective goods by reason of actions or omission of the Buyer; or
  - iii. Was only rendered the defective part or became defective goods by reason of instructions or warnings given or omitted by the Buyer or other supplier of the said composite goods supplied hereunder.
- c) For the purposes of this condition the word "defective" shall be interpreted in accordance with the definition contained in the Act and this condition shall mutatis mutandis apply in relation to equivalent legislation of other states as it applies in relation to the Act.

## 17. Law and Jurisdiction

This contract shall be governed and construed according to the Law of England and the parties hereby agree to submit to the exclusive jurisdiction of the English courts.



# Pegler Yorkshire

*Our brands:*

**terrier**

HEATING SOLUTIONS

**YORKSHIRE**

SOLDER RING SOLUTIONS

**Tectite**

PUSH-FIT SOLUTIONS

**XPress**

PRESS-FIT SOLUTIONS

**ENDEX**

END FEED SOLUTIONS

**KUTERLITE**

COMPRESSION SOLUTIONS

**PRESTEX**

DOMESTIC VALVE SOLUTIONS

**PEGLER**

COMMERCIAL VALVE SOLUTIONS

**meibes**

SOLAR SOLUTIONS

**HENCO**

MULTILAYER SOLUTIONS

**PROFLOW**

UTILITY SOLUTIONS

**PERFORMA**

UTILITY TAP AND MIXER SOLUTIONS

francis  
pegler

LUXURY TAP SOLUTIONS

## *UK sales*

Free Phone: 0800 156 0010

Free Fax: 0808 156 1011

Email: [uk.sales@pegleryorkshire.co.uk](mailto:uk.sales@pegleryorkshire.co.uk)

## *Export*

Tel: +44 (0) 1302 855 656

Fax: +44 (0) 1302 730 513

Email: [export@pegleryorkshire.co.uk](mailto:export@pegleryorkshire.co.uk)

## *Technical Help*

Free Phone: 0800 156 0050

Free Fax: 0808 156 1012

Email: [tech.help@pegleryorkshire.co.uk](mailto:tech.help@pegleryorkshire.co.uk)

## *Brochure Hotline*

Free Phone: 0800 156 0020

Free Fax: 0808 156 1011

Email: [info@pegleryorkshire.co.uk](mailto:info@pegleryorkshire.co.uk)

[www.pegleryorkshire.co.uk](http://www.pegleryorkshire.co.uk)

## **Pegler Yorkshire Group Limited**

St. Catherine's Avenue, Doncaster,  
South Yorkshire, DN4 8DF, England.

Tel: 0844 243 4400 Fax: 0844 243 9870

Registered in England Company No. 00401507

Registered Office: Haigh Park Road, Stourton, Leeds,  
West Yorkshire, LS10 1RT, England.

All brand names and logo styles are registered trademarks.  
Maintaining a policy of continual product development,  
Pegler Yorkshire reserves the right to change specifications, design  
and materials of products listed in this publication without prior notice.

LIT.REF: WEB ONLY